

Keep this
manual onboard!



User Manual

Including Installation Guide for S-Link Display Interface, SDI-1



DOCUMENT ID: 723I

REVISION: 7

DATE: 2024

LANGUAGE: EN



Contents

Warnings and Safety	2
User Manual	
Responsibility of the Operator	3
Product Description	3
Layout & Functions	3
SDI-1 Technical Specifications	3
SDI-1 Sleipner App	4
SDI-1 Thruster Dashboard	4
SDI-1 Stabilizer Dashboard	5
SDI-1 Alarm Indication.....	6
SDI-1 Setting Menu	7
SDI-1 Firmware Upgrade.....	7
S-Link Fault Codes	8
Online Troubleshooting and Fault Codes	8
Installation Manual	
Responsibility of the Installer	9
SDI-1 Dimensions	10
SDI-1 Installation	11
S-Link System Description	12
Service and Support	13
Product Spare Parts and Additional Resources	13
Warranty Statement	13
Patents	13
CE Declaration of Conformity	14
UK Declaration of Conformity	15

Warnings and Safety

MC_0800

It is essential to follow all instructions within this document to avoid potential personal injury, death, or damage to existing products in the vessel, the vessel's hull integrity, and including this product during installation or operation. Failure to follow instructions within this document will render all warranties given by Sleipner Motor as VOID.

Warnings and situations requiring extra caution are outlined in the documentation. Take extra consideration when warnings are outlined.



WARNING

Indicate a potentially hazardous situation that, if not avoided, could result in death or severe injury.



CAUTION

Indicates a potentially hazardous situation that could result in minor or moderate injury or critical damage to vessel integrity if not avoided.



Sleipner Motor AS
P.O. Box 519, Arne Svendsensgt. 6-8
N-1612 Fredrikstad, Norway

MC_0451

General:

- The operator must read this document to ensure necessary familiarity with the product before use.
- It is the owner/ captain/ operators full responsibility to assess the risk of any unexpected incidents or situation on the vessel or at sea. Familiarise yourself with your vessels safety operation in conjunction with Sleipner products.
- DO NOT allow children to operate Sleipner products.



WARNING

Sleipner Motor AS is not responsible for damage or injury caused by the misuse of our products.

Product Description

S-Link Display Interface (SDI-1) can be used to display status and operational information from Sleipner products on Multi-Function Displays (MFD). All Sleipner S-Link compliant thrusters and stabilizer systems are supported by SDI-1, except PHC-024.

Compatibility

SDI-1 supports MFDs from the following manufacturers:

- Garmin
- Raymarine
- Navico/Simrad

Contact MFD manufacturer for list of compatible models.

Layout & Functions

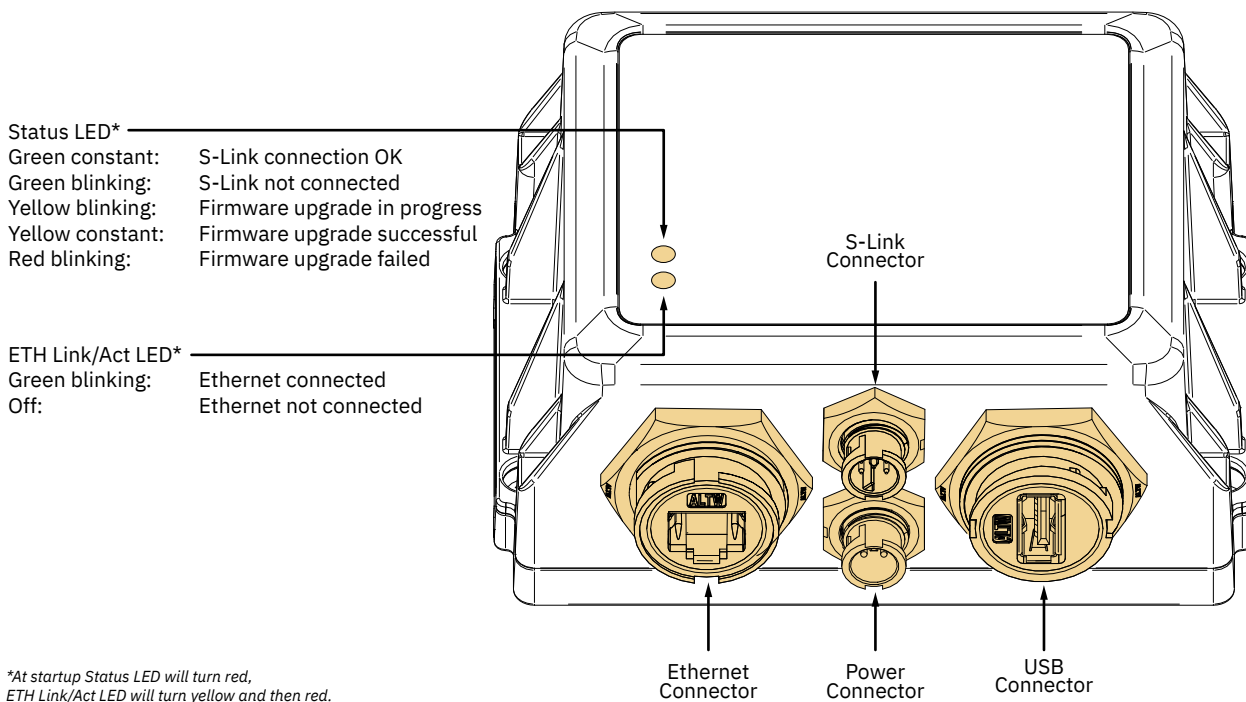

*At startup Status LED will turn red, ETH Link/Act LED will turn yellow and then red.

SDI-1 Technical Specification

Parameter	Specification		
Supply Voltage	Min 9VDC	Typical 12V/24V	Max 31VDC
Rated max input power:			
Power connector	6.5W		
S-Link connector	1.5W		
Ambient operating temperature	-20°C to +70°C		
IP rating	IP68		
Weight	290g		
Size	84x118x54mm (WxLxH)		

After correct installation and powering up SDI-1 the Sleipner app will appear on MFDs compatible with SDI-1. See MFD user manual for information on how to start third party apps and configuring screen layout.

The Sleipner app offers two dashboards, displaying either thruster or stabilizer information.

SDI-1 Thruster Dashboard

The thruster dashboard view shows thruster type, applied thrust, direction of thrust and status information from up to four thrusters. The status information is oriented on the dashboard according to the physical location of the thrusters.

For installations with two bow thruster, one joystick is used to operate both bow thrusters. The same amount of thrust is therefore applied to both thrusters and there is one common indicator for the amount and direction of thrust of both bow thrusters on the dashboard view. The same applies for vessels with two stern thrusters.

Switching between Thruster and Stabilizer dashboard can be done by clicking on the buttons on the bottom of the touch screen.

Thruster Dashboard Detailed Information

Below is an example of an installation with both bow and stern AC thrusters.

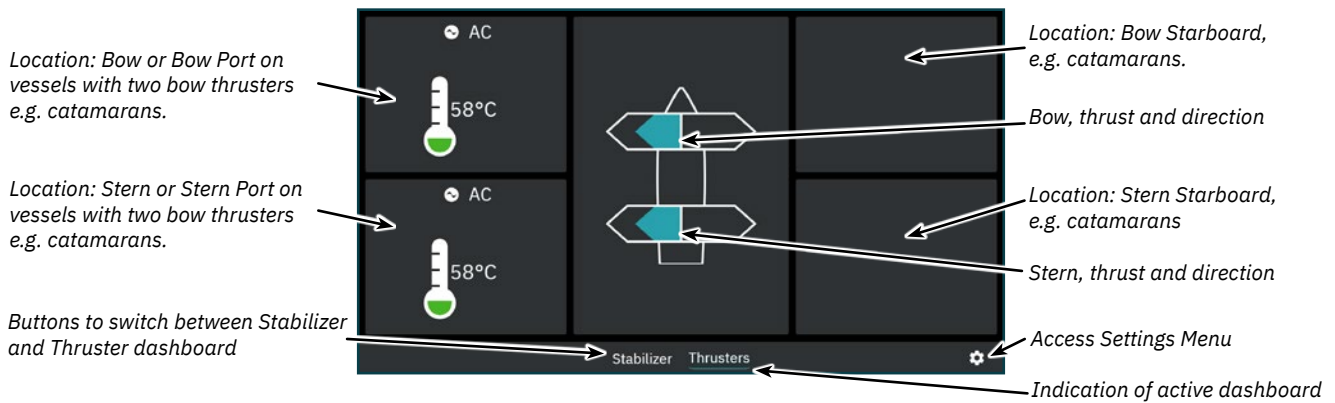

Below figure describes dashboard status information for different thruster types.

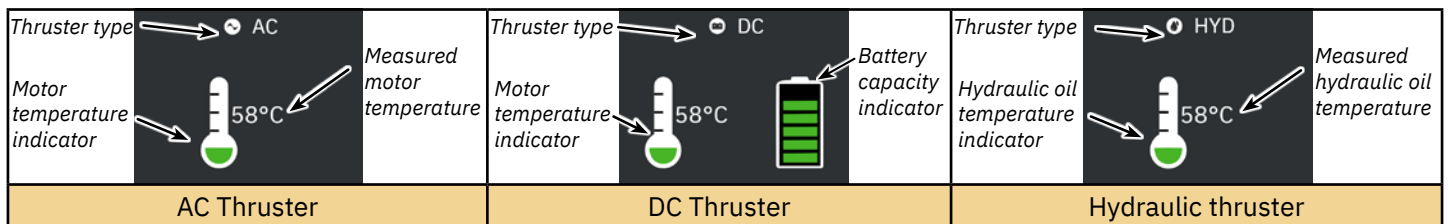

For hydraulic thrusters, the PHC-3 hydraulic controller can be used to control up to two hydraulic thrusters. Thus the dashboard view shows only one hydraulic oil temperature symbol for installations where one PHC-3 hydraulic controller is used to control two thrusters.

The temperature icon has five levels.

Green signifies normal temperature - Yellow signifies high temperature - Red signifies alarm stated due to too high temperature.



The battery status icon for DC thrusters has six levels.

The shaded area in the battery symbol indicates the remaining battery capacity.



Retractable Thruster

Deployment and retracting of retractable thrusters is controlled by turning a control panel ON or OFF. When the control panel is turned ON, retractable thrusters are deployed. The *Deploy* symbol is displayed in the dashboard view until the thruster is fully deployed. Turning OFF the panel will fully retract the thruster and the *Retract* symbol is displayed in the dashboard view until the thruster is fully retracted.

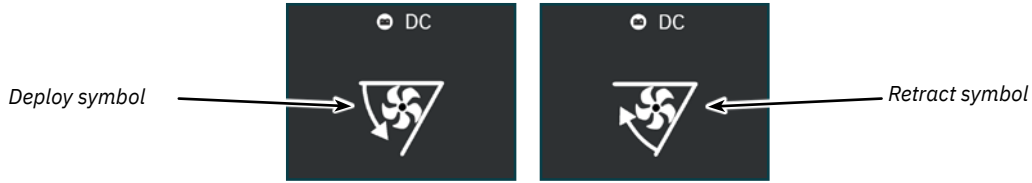

AC Thruster Power Management Status

Some vessels might not have AC power capabilities to run all consumers simultaneously. Such vessels typically use a power management system to control at which time different consumers can be operated. Due to other consumers having higher priority, power to the AC thrusters might not always be available. The following is only applicable for AC thrusters.

When a control panel is turned ON, a request is sent to the Variable Frequency Drive (VFD) to check if power is available. While the control panel waits for power available confirmation from the VFD, operation of the AC thruster is not permitted. The *Waiting for VFD Power Available* symbol is displayed in the dashboard view while the control panel waits for confirmation that power is available for the AC thruster. An alarm is triggered if confirmation is not received within 60 seconds after turning the control panel ON.

See user manual of AC thruster for detailed information on power management operation.

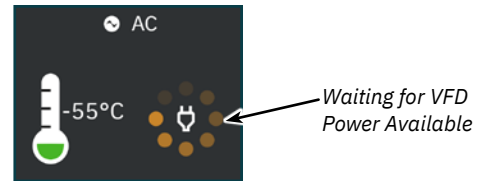

Operation with more than one Control Panel

Several control panels can be connected to the same S-Link bus and configured to control the same thruster. One example could be bridge and deck installation on the same vessel.

If two joysticks controlling the same thruster are moved in the same direction, but with different thrusts, the dashboard view will only indicate the thrust from the joystick with the highest level. Since this is the level of thrust the thruster will operate at.

If two joysticks controlling the same thruster are moved in the opposing direction, the thruster will not respond. In such situations the dashboard view will indicate no thrust. In such situations the thruster will not apply any thrust until one of the joysticks has returned to zero position.

SDI-1 Stabilizer Dashboard

The stabilizer dashboard allows the user to turn the stabilizer system ON and OFF, and switch between At Anchor or Cruising. The roll and speed of the vessel is displayed in the top part of the stabilizer dashboard. Each installed fin is represented by a fin icon on the dashboard. The fin icon displays the actual movement of the fins. A lock icon is used to indicate if the fins are locked in a fixed position.

Switching between Thruster and Stabilizer dashboard can be done by clicking on the buttons on the bottom of the touch screen.

Stabilizer Dashboard Detailed Information

Below is an example of an installation with four stabilizer fins.

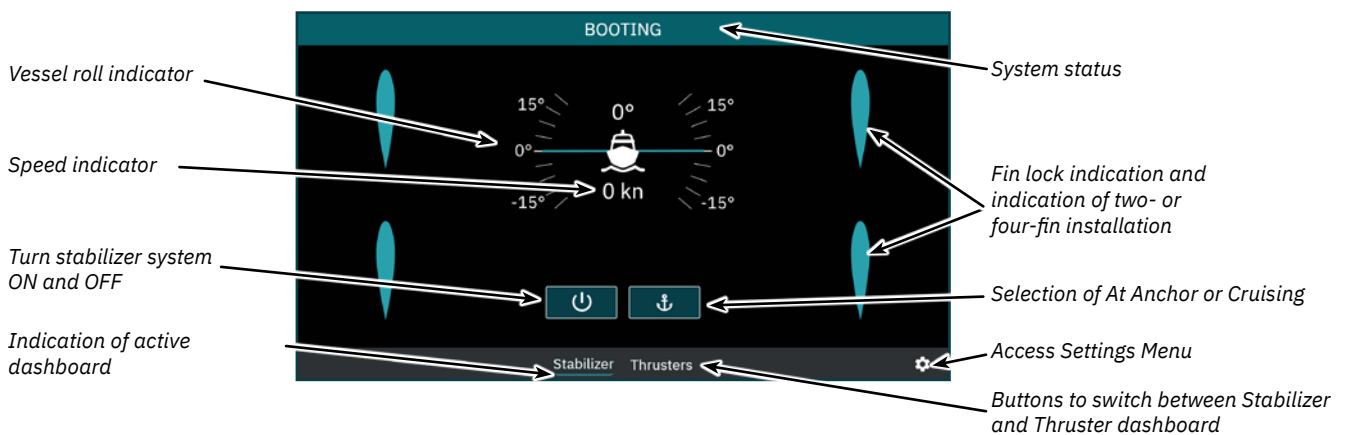

SDI-1 Alarm Indication

If a device connected to the S-Link bus enters an alarm state, an alarm message is broadcasted on the S-Link bus. If an alarm message is detected by SDI-1 a notification will appear on the MFD and additional alarm information will be available. The Sleipner app must be running on the MFD to enable alarm notifications.

Alarm indication thruster dashboard

In the thruster dashboard alarm state is indicated by a blinking red background, and the *Access Alarm List* icon will be displayed in the lower-left corner. Press the *Access Alarm List* icon to show a list of active alarms.

It is not possible to operate a thrusters with active alarms. Exceptions are Oil over temperature- and Low oil level alarms generated by PHC3.

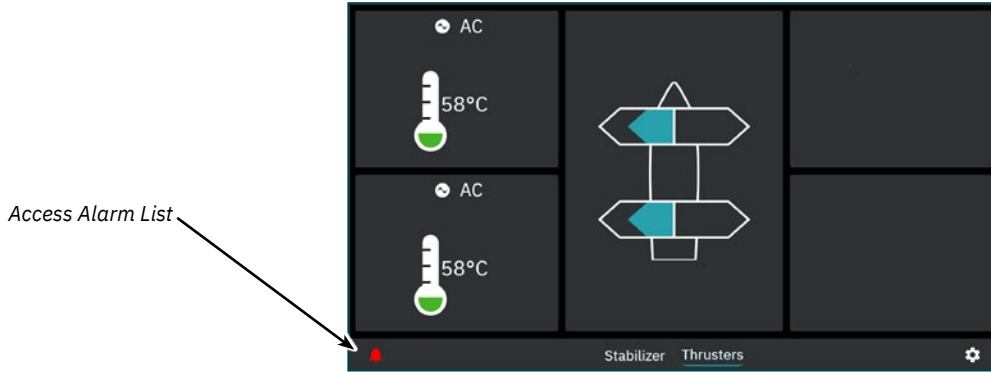

Alarm indication stabilizer dashboard

In the stabilizer dashboard alarm state is indicated by the *Access Alarm List* icon in the lower left corner. Press the *Access Alarm List* icon to show list of active alarms.

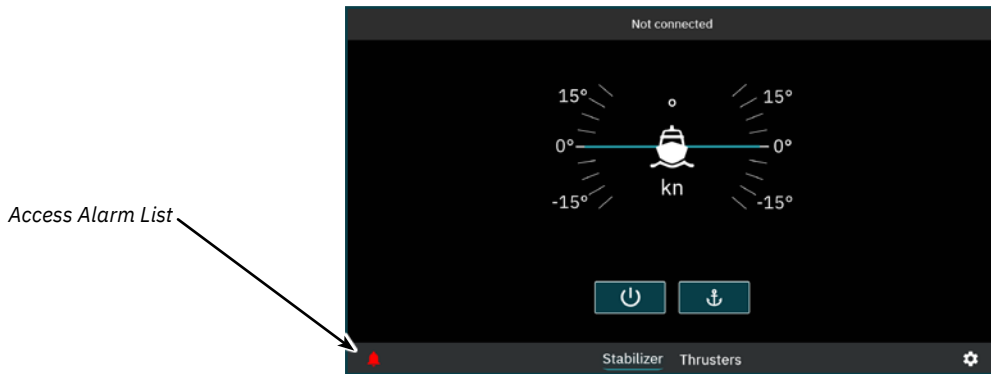

Alarm list

All active thruster and stabilizer alarms are displayed in the alarm list.

DMC_SCU	No instance	45003.100.200
FCU Communication, Fin bow port, Timeout		
DMC_SCU	No instance	45003.101.200
FCU Communication, Fin bow starboard, Timeout		
DMC_SCU	No instance	45003.102.200
FCU Communication, Fin stern port, Timeout		
DMC_SCU	No instance	40004.0.100
PHC-3, -, No Communication		
DMC_SCU	No instance	45003.103.200
FCU Communication, Fin stern starboard, Timeout		

SDI-1 Settings Menu

Configuration settings for stabilizer are available from the *Settings Menu*. In addition SDI-1 FW version, HW version and serial number can be found in the *About* section of the *Setting Menu*.

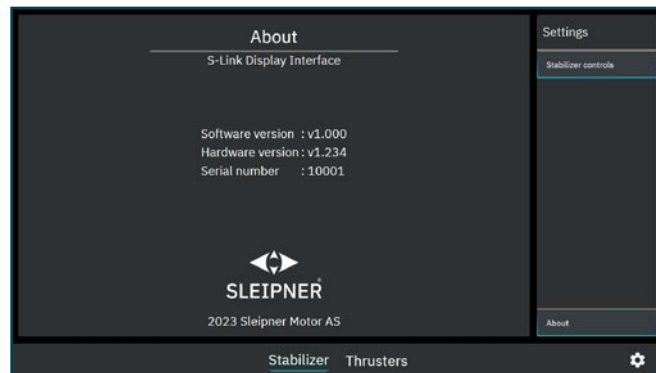

SDI-1 Firmware Upgrade

MC_0547

The USB port on SDI-1 can be used for firmware upgrade by following the steps below:

1. Download the latest firmware to a USB flash drive. The latest firmware can be downloaded from S-Link Programmer, see www.sleipnergroun.com for more information and download of S-Link Programmer.
2. Power up SDI-1 and wait for Status LED to turn green or green blinking.
3. Install the flash drive in the USB port of SDI-1.
4. The Status LED will start blinking yellow when the firmware upload process is started. SDI-1 will function as normal during the firmware upgrade process. If the upgrade fails, the Status LED will turn red. Removing the flash drive after failed upgrade will change the Status LED to green or green blinking.
5. After a successful upgrade the Status LED will stop blinking and turn yellow. SDI-1 must be restarted to start using the new firmware. Removing the flash drive will reboot SDI-1.

Fault situations in S-Link compliant products generates Fault Codes which are broadcasted on the S-Link bus. If a control panel receives a Fault Code, it will trigger an alarm in the control panel and the user will be able to get information about which product that reports the fault and the reason for the fault. Please see the user manual of your S-Link compliant control panel for more information on how to access Fault Code information in case of an alarm situation.

All Sleipner S-Link compliant products have product specific Fault Codes. For legacy reasons some control panels display Generic Fault Codes for certain products.

Online Troubleshooting and Fault Codes

For the latest fault codes scan the QR code below for quick access to our Fault code lookup database register.



Or visit our website via
www.sleipnergroun.com/support/fault-code-navigator
to download a print copy of the Sleipner product fault code register

Responsibility of the installer

MC_0038

General:

- The installer must read this document to ensure necessary familiarity with the product before installation.
- Directions outlined in this document cannot be guaranteed to comply with all international and national regulations, including but not limited to health and safety procedures. It is the installers responsibility to adhere to all applicable international and national regulations when installing Sleipner products.
- This document contains general installation guidelines intended to support experienced installers. Contact professional installers familiar with the vessel, Sleipner products and applicable regulations if assistance is required.
- If local regulation requires any electrical work to be performed by a licensed professional, seek a licensed professional.
- When planning the installation of Sleipner products, ensure easy access to the products for future service and inspection requirements.

For Sleipner S-Link™ systems:

MC_0105

- When installing an S-Link™ system, connect ONLY original Sleipner S-Link™ products or other authorized control equipment directly to the S-Link™ bus. When connecting non-authorized third-party equipment, it must always be connected through a Sleipner-supplied interface product.
- Any attempt to directly control or connect to the S-Link™ control system without a designated and approved interface from Sleipner will void all warranties and responsibilities of the connected Sleipner products. If you interface the S-Link™ bus by agreement with Sleipner through a designated Sleipner-supplied interface, you are still required to install at least one original Sleipner control panel to enable efficient troubleshooting if necessary.

Dimension code	Dimension description	mm	inch
L	Length	118	2
W	Width	84	4.6
H	Height	54	3.3
(a)	Distance between mounting holes	46	1.8
(b)	Distance between mounting holes	108	4.3

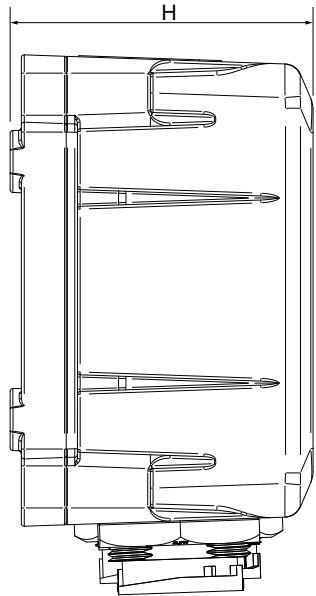
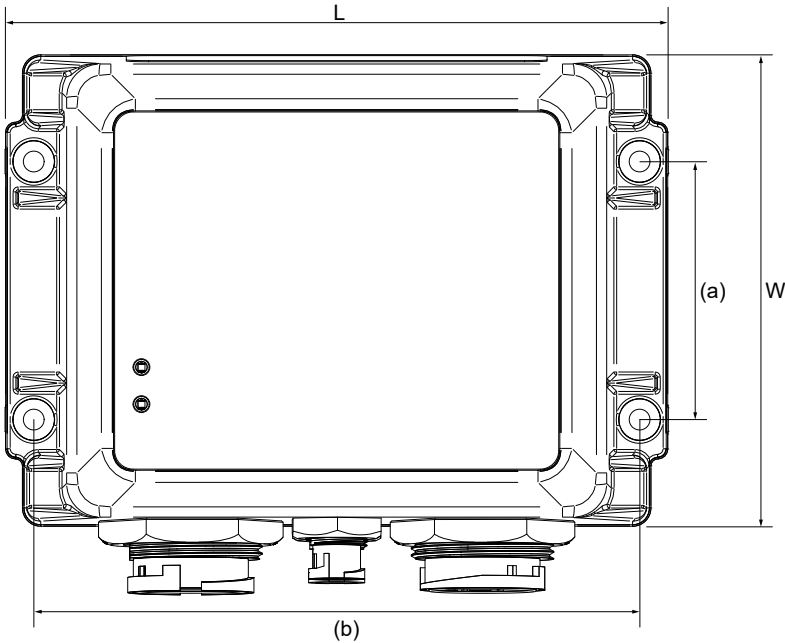

MG_0703

1. Fasten the SDI-1 box to a solid surface using four mounting screws.
2. Connected a S-Link SPUR Cable between SDI-1 and a T-connector on the S-Link BACKBONE Cable. See *S-Link System Description* chapter for detailed information about the S-Link system.
3. Connect an Ethernet cable between SDI-1 and the Multi-Function Display (MFD). For most MFDs the Ethernet cable could be connected to a switch on the same net as the MFD.
4. Connect power cable supplying 12V/24V. The supply should be protected with a 1A/0.5A fuse. To be able to completely turn off SDI-1 a switch could be connected on the supply.

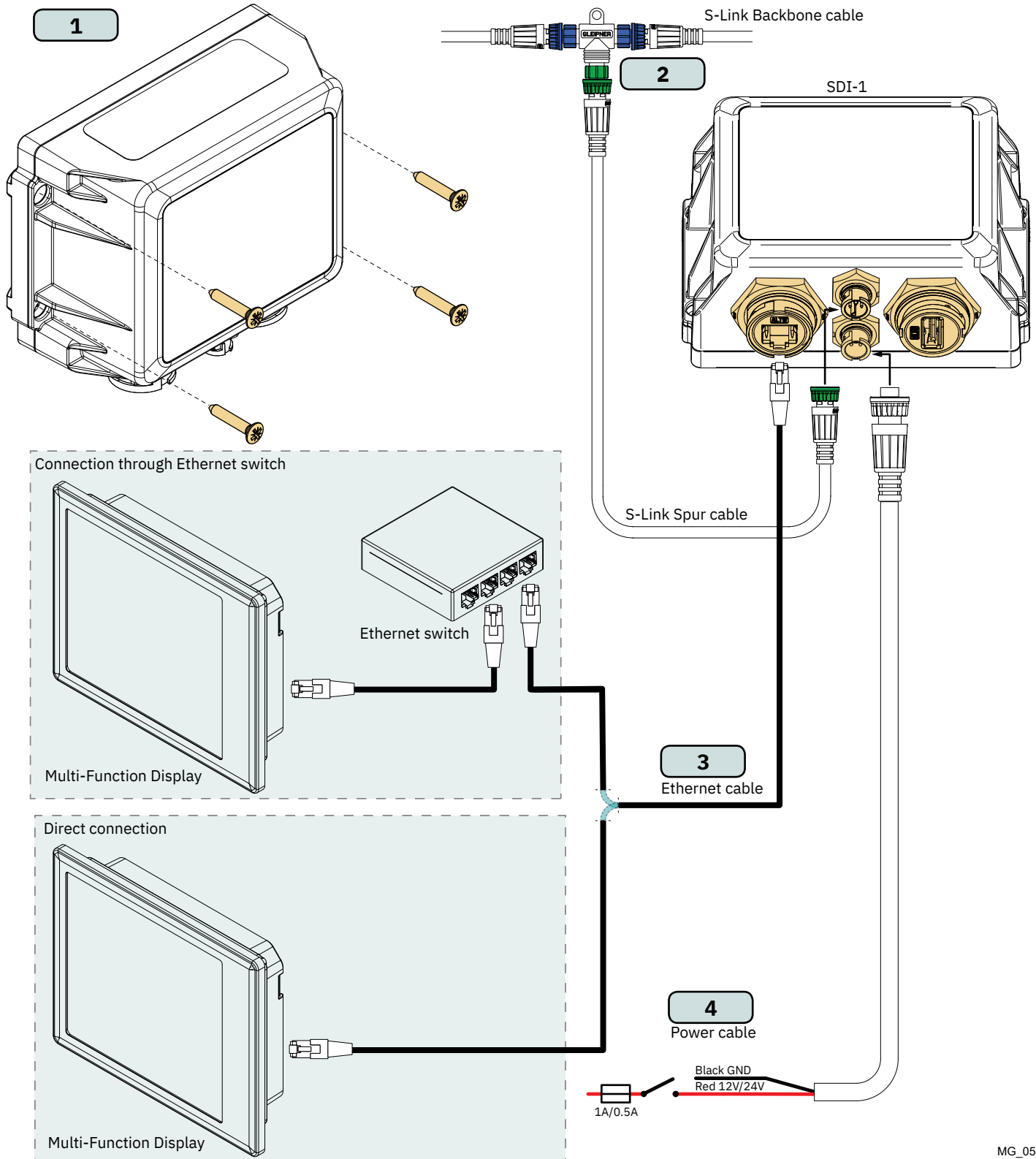

S-Link is a CAN-based control system used for communication between Sleipner products installed on a vessel. The system uses BACKBONE Cables as a common power and communication bus with separate SPUR Cables to each connected unit. Only one S-Link POWER cable shall be connected to the BACKBONE Cable. Units with low power consumption are powered directly from the S-Link bus.

Main advantages of S-Link system:

- Compact and waterproof plugs.
- BACKBONE and SPUR Cables have different colour coding and keying to ensure correct and easy installation. BACKBONE Cables have blue connectors and SPUR Cables have green connectors.
- Different cable lengths and BACKBONE Extenders make the system scalable and flexible to install.

Installation of S-Link cables:

Select appropriate cables to keep the length of BACKBONE- and SPUR Cables to a minimum. In case of planned installation with total BACKBONE Cable length exceeding 100 meters please consult your local distributor. The S-Link cables should be properly fastened when installed to avoid sharp bend radius, cable chafing and undesired strain on connectors. Locking mechanism on connectors must be fully closed. To ensure long lifetime, cables, T-Connectors and Extenders should not be located so that they are permanently immersed in water or other fluids. It is recommended to install cables in such a way that water and condensation do not flow along the cables into the connectors. This can be done for example by introducing a u-shape bend before the cable enters the product connector.

Ideally, the POWER Cable should be connected to the middle of the BACKBONE bus to ensure an equal voltage drop at both ends of the BACKBONE Cable. The yellow and black wire in the POWER Cable shall be connected to GND and the red wire connected to +12VDC or +24VDC.

To reduce the risk of interference, avoid routing the S-Link cables close to equipment such as radio transmitters, antennas or high voltage cables. The backbone must be terminated at each end with the END Terminator.

SPUR cables can be left unterminated to prepare for the installation of future additional equipment. In such cases, ensure to protect open connectors from water and moisture to avoid corrosion in the connectors.

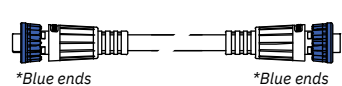

BACKBONE Cable

Forms the communication and power bus throughout a vessel. Available in different standard lengths.

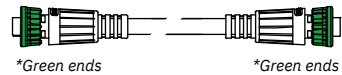

SPUR Cable

Used to connect S-Link compliant products to the backbone cable. One SPUR Cable must be used for each connected component, with no exceptions. Recommended to be as short as practically possible. Available in different standard lengths.

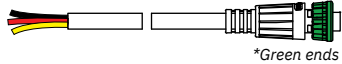

POWER Cable

Required in all installations for connection of BACKBONE Cable to a power supply and should be protected with a 2A fuse.

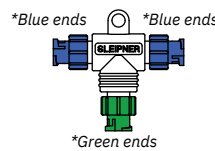

T-Connector

Used for connection of SPUR or POWER Cable to the BACKBONE Cable. One T-Connector for each connected cable.



BACKBONE Extender

Connects two BACKBONE Cables to extend the length.

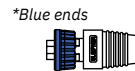

END Terminator

Must be one at each end of the BACKBONE bus.

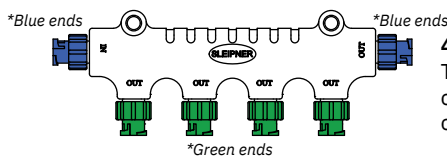

4-Port T-Connector

The 4-PORT T-connector allows multiple SPUR Cables to be connected. The 4-PORT T-connector comes with two sealing caps to protect unused ports.

S-Link installation example

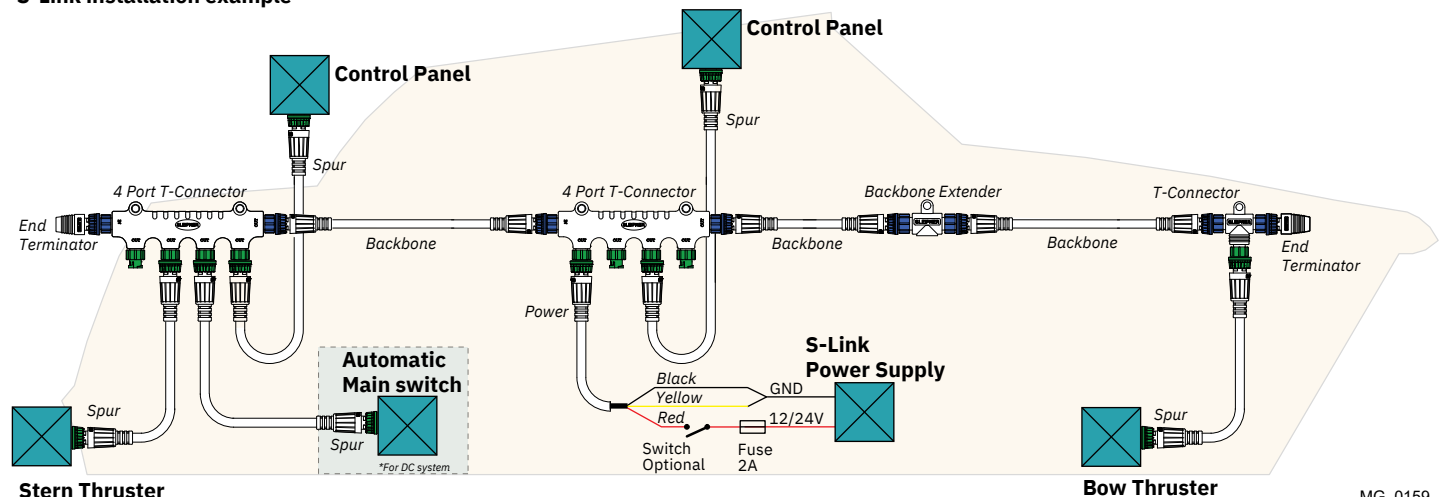

Find your local professional dealer from our certified worldwide network for expert service and support. visit our website www.sleipnergrou.com/support

Product spare parts and additional resources

For additional supporting documentation, we advise you to visit our website www.sleipnergrou.com and find your Sleipner product.

Warranty statement

1. Sleipner Motor AS (The “Warrantor”) warrants that the equipment (parts, materials, and embedded software of products) manufactured by the Warrantor is free from defects in workmanship and materials for purpose for which the equipment is intended and under normal use and maintenance service (the “Warranty”).
2. This Warranty is in effect for two years (Leisure Use) or one year (Commercial and other Non-leisure Use) from the date of delivery/purchase by the end user, with the following exceptions;
 - (a) For demonstration vessels, or vessels kept on the water, the dealer is considered as the end user from 6 months after their launch of the vessel;
 - (b) The warranty period starts no later than 18 months after the first launch of the vessel.
 Please note that the boat manufacturer and dealer must pay particular attention to correct maintenance and service both by the products manuals as well as general good practice for the location the boat is kept in the period the boat is in their care. In cases where the 6 and 18 months grace periods for boat builders and dealers are passed, it is possible to obtain a full warranty upon inspection and approval of the warrantor or such representative.
3. Certain parts, classified as wearable or service parts, are not covered by the warranty. A failure to follow the required maintenance and service work as described in the product manual render all warranty on parts or components directly or indirectly affected by this void. Please also note that for some parts, time is also a factor separately from actual operational hours.
4. This Warranty is transferable and covers the equipment for the specified warranty period.
5. The warranty does not apply to defects or damages caused by faulty installation or hook-up, abuse or misuse of the equipment including exposure to excessive heat, salt or fresh water spray, or water immersion except for equipment specifically designed as waterproof.
6. In case the equipment seems to be defective, the warranty holder (the “Claimant”) must do the following to make a claim:
 - (a) Contact the dealer or service centre where the equipment was purchased and make the claim. Alternatively, the Claimant can make the claim to a dealer or service centre found at www.sleipnergrou.com. The Claimant must present a detailed written statement of the nature and circumstances of the defect, to the best of the Claimant’s knowledge, including product identification and serial nbr., the date and place of purchase and the name and address of the installer. Proof of purchase date should be included with the claim, to verify that the warranty period has not expired;
 - (b) Make the equipment available for troubleshooting and repair, with direct and workable access, including dismantling of furnishings or similar, if any, either at the premises of the Warrantor or an authorised service representative approved by the Warrantor. Equipment can only be returned to the Warrantor or an authorised service representative for repair following a pre-approval by the Warrantor’s Help Desk and if so, with the Return Authorisation Number visible postage/shipping prepaid and at the expense of the Claimant.
7. Examination and handling of the warranty claim:
 - (a) If upon the Warrantor’s or authorised service Representative’s examination, the defect is determined to result from defective material or workmanship in the warranty period, the equipment will be repaired or replaced at the Warrantor’s option without charge, and returned to the Purchaser at the Warrantor’s expense. If, on the other hand, the claim is determined to result from circumstances such as described in section 4 above or a result of wear and tear exceeding that for which the equipment is intended (e.g. commercial use of equipment intended for leisure use), the costs for the troubleshooting and repair shall be borne by the Claimant;
 - (b) No refund of the purchase price will be granted to the Claimant, unless the Warrantor is unable to remedy the defect after having a reasonable number of opportunities to do so. In the event that attempts to remedy the defect have failed, the Claimant may claim a refund of the purchase price, provided that the Claimant submits a statement in writing from a professional boating equipment supplier that the installation instructions of the Installation and Operation Manual have been complied with and that the defect remains.
8. Warranty service shall be performed only by the Warrantor, or an authorised service representative, and any attempt to remedy the defect by anyone else shall render this warranty void.
9. No other warranty is given beyond those described above, implied or otherwise, including any implied warranty of merchantability, fitness for a particular purpose other than the purpose for which the equipment is intended, and any other obligations on the part of the Warrantor or its employees and representatives.
10. There shall be no responsibility or liability whatsoever on the part of the Warrantor or its employees and representatives based on this Warranty for injury to any person or persons, or damage to property, loss of income or profit, or any other incidental, consequential or resulting damage or cost claimed to have been incurred through the use or sale of the equipment, including any possible failure or malfunction of the equipment or damages arising from collision with other vessels or objects.
11. This warranty gives you specific legal rights, and you may also have other rights which vary from country to country.

Patents

At Sleipner we continually reinvest to develop and offer the latest technology in marine advancements. To see the many unique designs we have patented, visit our website www.sleipnergrou.com/patents

CE Declaration of conformity (DoC)

We, the manufacturer:	Sleipner Motor AS Arne Svendsens gate 6-8, NO 1612 Fredrikstad, Norway	
With ISO 9001 certificate:	1484-2007-AQ-NOR-NA, issued by DNV-GL	
Declare that the product: Product Description: S-Link Display Interface Model Number: SDI-1		
Subject to installation, maintenance and use conforming to their intended purpose, is in conformity with the provisions of the following EU Directives: <ul style="list-style-type: none"> • Radio equipment - Directive 2014/53/EU • Restriction of the Use of certain Hazardous Substances in Electrical and Electronic Equipment (RoHS) - Directive 2011/65/EU 		
The product is designed to meet the standards and criteria outlined in:	Radio	EN 300 328 V2.2.2 EN 301 893 V2.1.1 EN 50385:2017
	EMC	EN 60945:2002 IEC 60533:2015 EN 301 489-1 V2.2.0 EN 301 489-17 V3.2.0
	Safety	EN 62368-1:2020 EN 62311:2008
	RoHS	EN 63000:2018

This declaration of conformity is issued under the exclusive responsibility of the manufacturer.

Fredrikstad, 24th of October 2022

Ronny Skauen, President and CEO



UK Declaration of conformity (DoC)

We, the manufacturer:	Sleipner Motor AS Arne Svendsens gate 6-8, NO 1612 Fredrikstad, Norway	
With ISO 9001 certificate:	1484-2007-AQ-NOR-NA, issued by DNV-GL	
Declare that the product:	<p>Product Description: S-Link Display Interface</p> <p>Model Number: SDI-1</p>	
Subject to installation, maintenance and use conforming to their intended purpose; is in conformity with the provisions of the following UK Regulations:	<ul style="list-style-type: none"> • Radio Equipment Regulations 2017 • The Restriction of the Use of Certain Hazardous Substances in Electrical and Electronic Equipment Regulations - 2012 	
The product is designed to meet the standards and criteria outlined in:	Radio	EN 300 328 V2.2.2 EN 301 893 V2.1.1 EN 50385:2017
	EMC	EN 60945:2002 IEC 60533:2015 EN 301 489-1 V2.2.0 EN 301 489-17 V3.2.0
	Safety	EN 62368-1:2020 EN 62311:2008
	RoHS	EN 63000:2018

This declaration of conformity is issued under the exclusive responsibility of the manufacturer.

Fredrikstad, 24th of October 2022

Ronny Skauen, President and CEO



© **Sleipner Group**, All rights reserved
The information given in the document was right at the time it was published. However, Sleipner Group cannot accept liability for any inaccuracies or omissions it may contain. Continuous product improvement may change the product specifications without notice. Therefore, Sleipner Group cannot accept liability for any possible differences between product and document.

Learn more about our products at
www.sleipnergroun.com



SLEIPNER MOTOR AS

P.O. Box 519

N-1612 Fredrikstad

Norway

www.sleipnergroun.com

Made in Norway