

# Installation and User Manual

For Control Panels  
PJC211 & PJC212



## Table of content

Warnings and Safety .....	3
General Operation Consideration and Precaution Guidelines .....	3
<b>User Manual</b>	
Panel Layout & Functions .....	4
Manoeuvring.....	5
Setup Procedure .....	6
Firmware Changelog .....	7
Thruster Display .....	8
Thruster Display Symbols.....	9
Alarm System .....	10
Hold Function .....	11
Combining Hydraulic Stabilizer with AC or DC Thrusters .....	11
SAC Power Management Status.....	11
Main Menu.....	12
Language - Menu .....	13
Stabilizer - Menu.....	13
Setup - Menu .....	13
Setup - System Devices .....	13
Setup - PDC 101 AC System.....	14
Setup - PDC 201 AC System.....	14
Setup - PDC-301 AC System .....	15
Setup - AMS DC System .....	16
Setup - PPC DC System .....	17
Setup - eVision DC System .....	19
Setup - SR150000 Retract System .....	20
Setup - SR6 1242 Retract System .....	21
Setup - SRC-3 Retract System.....	21
Setup - RCRS 1 & RCR 2 Remote Control Receiver .....	21
Setup - MSI8730 S-Link Interface .....	22
Setup - ESI-1 External Signal Interface & GW-1 S-Link Gateway.....	23
Setup - Hold Calibration .....	23
Setup - Joystick Calibration .....	24
Info - Menu .....	24
Info - Thruster Info .....	24
Info - PPC, SR150000, SR6 1242 .....	24
Info - PDC 101 & PDC 201.....	25
Info - PDC-301.....	25
Info - eVision & EHP.....	25
Info - SRC-3.....	25
Info - PHC-3 & PHC024.....	25
Info - Panel Info .....	26
Info - S-Link Diagnostic .....	26
Default Settings - Menu .....	26
Panel Setup - Menu .....	27
S-Link Fault Codes .....	28
Fault Code Navigator.....	28
<b>Installation Manual</b>	
Responsibility of the Installer.....	29
Product Dimensions .....	30
Product Specifications .....	30
Control Panel Installation .....	31
S-Link System Description .....	32
List of Installed S-Link Devices.....	33
<b>Sleipner Group Waste Disposal and Recycling Guide .....</b>	<b>34</b>
<b>Service and Support.....</b>	<b>35</b>
<b>Product Spare Parts and Additional Resources.....</b>	<b>35</b>
<b>Patents.....</b>	<b>35</b>
<b>Warranty Statement.....</b>	<b>36</b>

It is essential to follow all instructions within this document to avoid potential personal injury, death, or damage to existing products in the vessel, the vessel's hull integrity, and including this product during installation or operation. Failure to follow instructions within this document will render all warranties given by Sleipner Motor as VOID.

Warnings and situations requiring extra caution are outlined in the documentation. Take extra consideration when warnings are outlined.

### **WARNING**

Indicates a hazardous situation which, if not avoided, could result in death or serious injury.

### **CAUTION**

Indicates a hazardous situation which, if not avoided, could result in minor or moderate injury or damage to the product.

MC\_0800

## General operation consideration and precaution guidelines

MC\_0444

### Safe Operation of Sleipner Thruster Systems

- When the thruster is not in use or when leaving the vessel unattended, always switch off the control device.
- When leaving the vessel, always switch off the main power supply to the thruster at the main switch.
- Never operate the thruster while the vessel is out of the water.
- If the thruster stops producing thrust during operation, stop immediately and switch off the thruster. Running the thruster for more than a few seconds without resistance from the propeller can cause severe damage to the drive components.
- The thruster will not operate if conflicting directional commands are given simultaneously from two control panels.
- If any fault, abnormal noise, vibration, or irregular operation is observed, switch off the thruster immediately to avoid further damage.
- The thruster is intended solely for manoeuvring and docking the vessel. When operating the thruster, the vessel's forward or reverse speed must not exceed 4 knots.

### **WARNING**

- Never use the thruster when persons, animals, or objects are in the water near the vessel. The thruster generates strong suction and will draw objects into the tunnel and rotating propeller. Contact with the rotating propeller will cause severe injury or death and can result in serious damage to the thruster.
- Always switch off the main power supply to the thruster before touching any part of the thruster system. Accidental start-up while handling moving parts can cause severe injury or death.
- Always ensure that a safe manoeuvring plan is in place. If the thruster stops producing thrust unexpectedly during manoeuvring, there is a risk of collision, grounding, or personal injury.

# PJC-211

MC\_0116

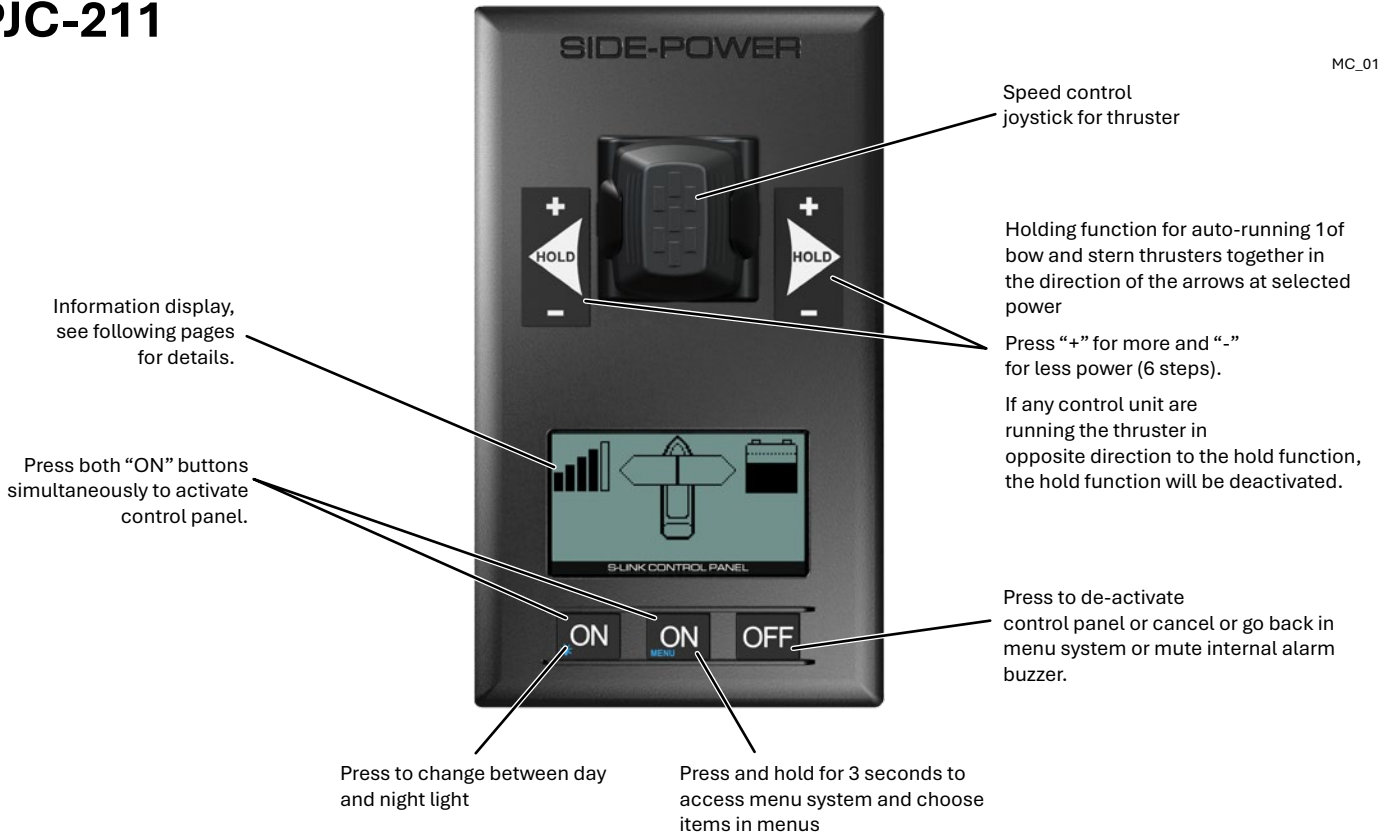

# PJC-212

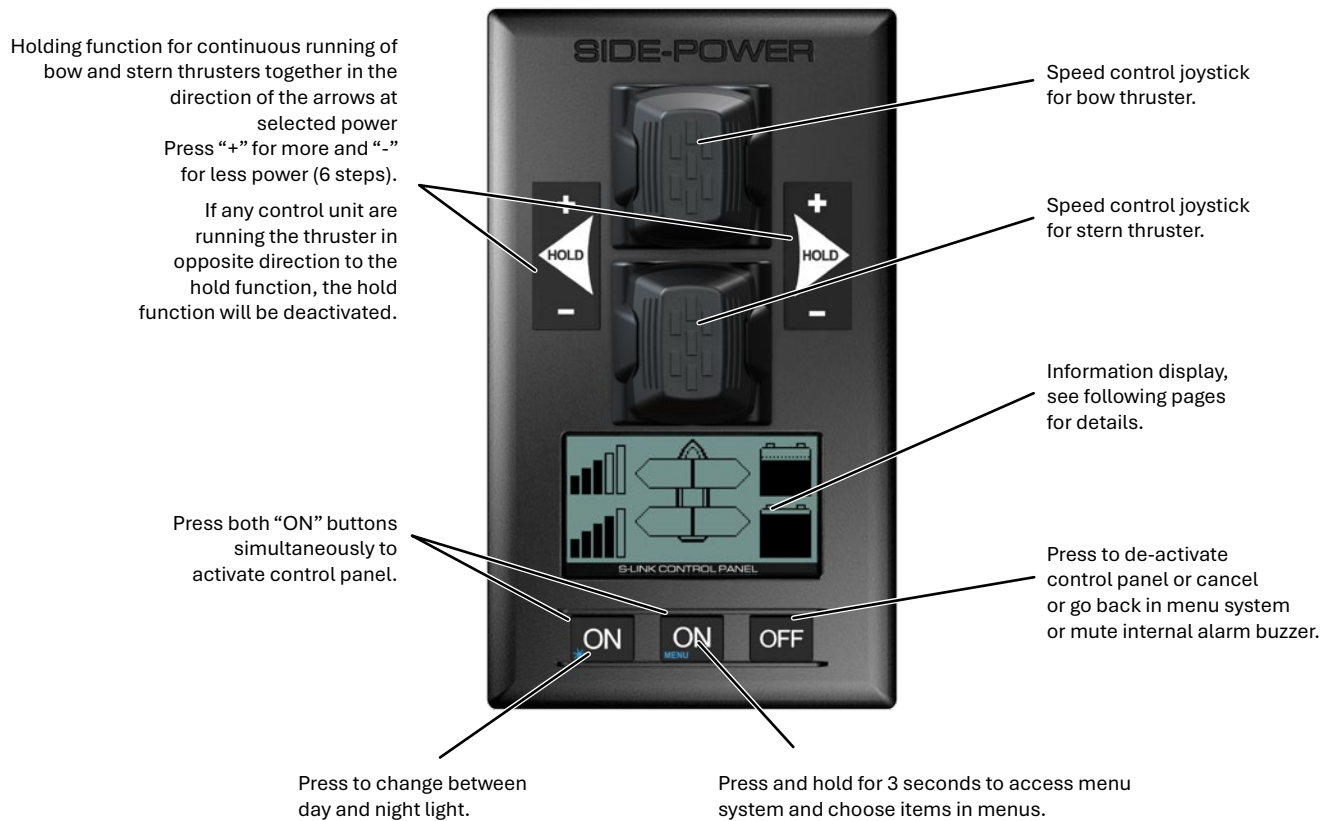

Activating the bow thruster



Activating the stern thruster

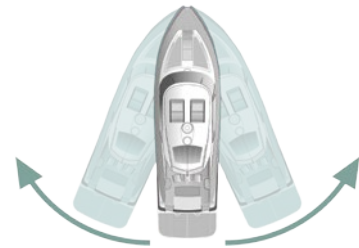

Activating both bow and stern thruster to push the boat sideways

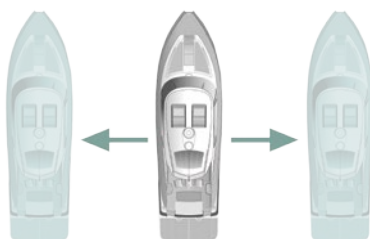
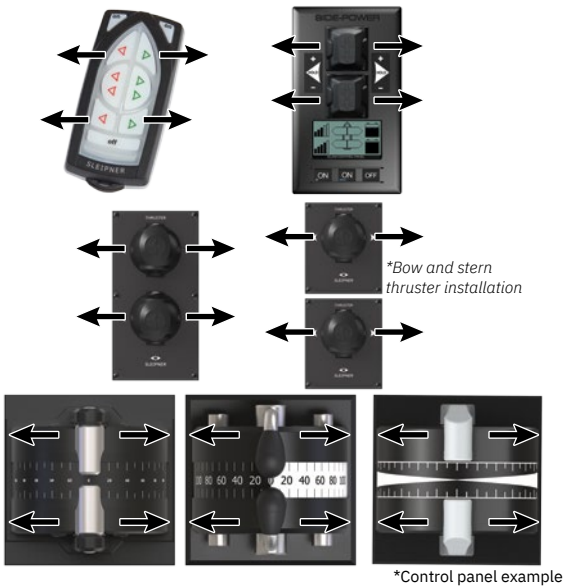

Activating both bow and stern thruster to rotate the boat on axis

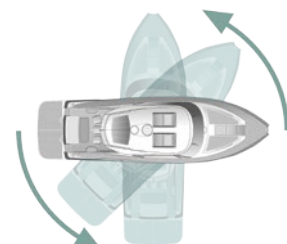
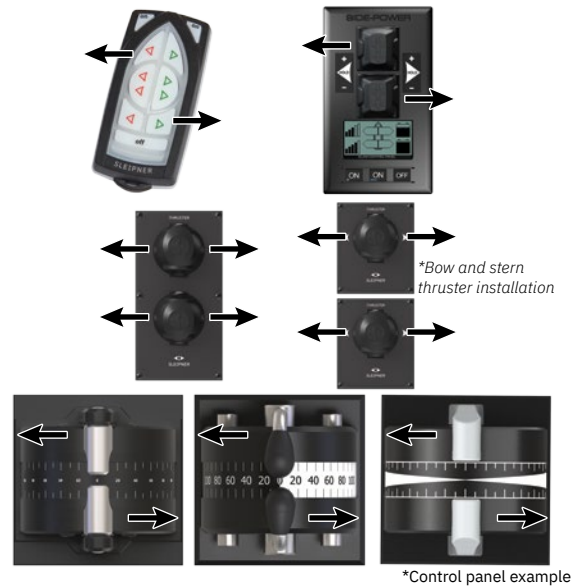

At the first start-up of a new system, one of the two screens below will be shown:

Note: **The setup procedure requires knowledge of the serial number and location of all the S-Link devices.**

At the first start-up of a new system, one of the two screens below will be shown:

**SETUP DO NOT MATCH SYSTEM.**

**PRESS ✓ FOR AUTO SETUP**

New devices found. Not in conflict with other devices. Press button below the  symbol to auto setup.

Thrusters can not be operated until auto setup is completed.



'OR'

**RUN SETUP! DEVICES IN CONFLICT!**

Detected devices in conflict. Two or more thrusters defined as same instance (bow/stern/bow STB Stern STB).

Run Setup procedure to correct.

Thrusters can not be operated until setup is completed.



Press and hold the button marked "MENU" for 3 seconds to enter the menu system. Use the (stern) joystick to select "SETUP", Press button below the  symbol to enter the "SETUP"-menu.



Use the (stern) joystick to select "SYSTEM DEVICES" menu.

Press button below the  symbol to enter the "SYSTEM DEVICES" menu.



Use the (stern) joystick to set the pin code one number at the time.

Press button below the  symbol to confirm and jump to next number.

The pin code is "9 9 9 9".



(NB: Re-entering the "SYSTEM DEVICES" menu within 15 minutes does not require entering PIN code.)

For about 2 seconds an hourglass will appear while scanning the S-Link for devices.

The devices found in the system are now displayed with their instance (thruster type and location) and serial number.

Go through all devices and make sure that they are set to the correct instance and function, refer to detailed instructions in the applicable "SETUP" section of this manual.



Press button below the  symbol to save setting and return to the "SETUP" menu.

Exiting the "SYSTEM DEVICES" menu stores the system setup and distributes the system setup to all PJC2xx panels connected to the S-Link bus. The system setup consist of type of devices and location of all Sleipner products connected to the S-Link bus.

MC\_0918

To ensure that all the functionality described in this document is available it is recommended that all Sleipner products are updated to the latest firmware version.

Sleipner Firmware upgrade tool kit for S-Link Programmer 6 1307 and the PC software S-Link Programmer can be used to upgrade Sleipner S-Link devices. S-Link Programmer enables access to a detailed FW changelog for Sleipner products. This changelog can be used to verify that the installed products have the required FW version for required functionality.

Download site and User Manual for S-Link Programmer can be accessed from [www.sleipnergroun.com](http://www.sleipnergroun.com) or directly by scanning this QR code:

MC\_0802





MC\_0947

Status indicators for bow thruster. (Port bow thruster in a dual bow thruster setup).

Runtime indicator will be shown here in a single DC electric bow thruster setup.

Status indicators for stern thruster. (Port bow thruster in a dual stern thruster setup)

Runtime indicator will be shown here in a single DC electric stern

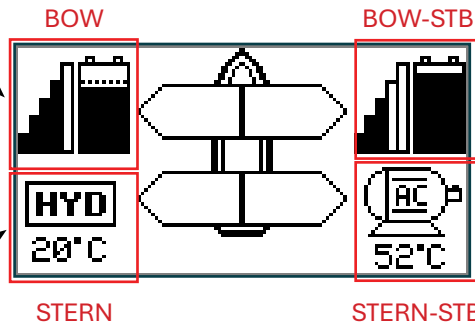

Status indicators for starboard bow thruster. Only shown in a dual bow thruster setup.

Battery indicator will be shown here in a single DC

Status indicators for starboard stern thruster. Only shown in a dual stern thruster setup.

Battery indicator will be shown here in a single DC electric stern thruster setup.

**Examples of display view for different panels applications:**

**PJC211:**

DC Electric Bow thruster

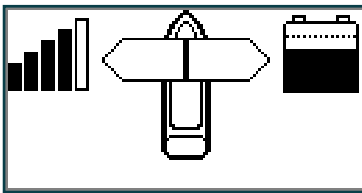

**PJC211:**

Hydraulic Bow thruster

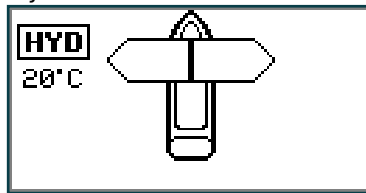

**PJC211:**

AC Electric Bow thruster

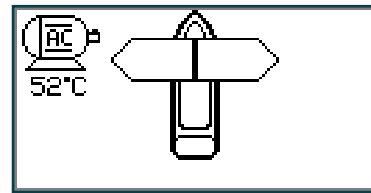

**PJC211:**

DC Electric Stern thruster

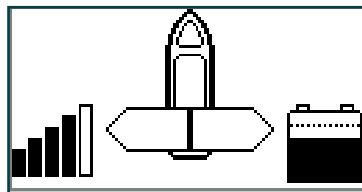

**PJC211:**

Dual AC Electric Bow thrusters

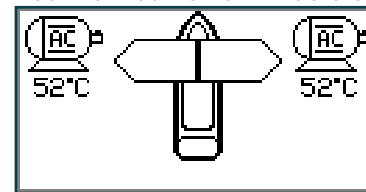

**PJC211:**

Dual Hydraulic Bow thrusters

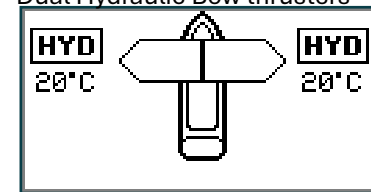

**PJC212:**

DC Electric Bow thruster  
DC Electric Stern Thruster

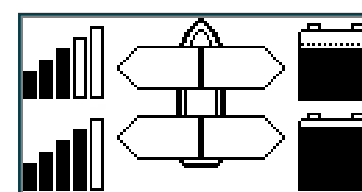

**PJC222:**

Hydraulic Bow thruster  
Hydraulic Stern Thruster

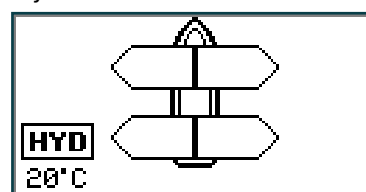

**PJC222:**

AC Electric Bow thruster  
Hydraulic Stern Thruster

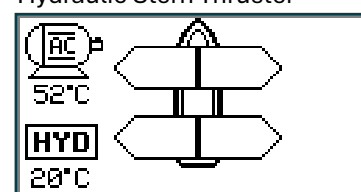

**PJC212:**

Dual DC Electric Bow thrusters  
Dual DC Electric Stern thrusters

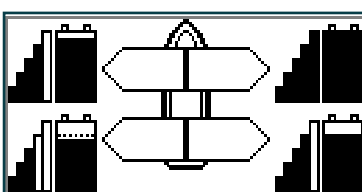

**PJC222:**

Dual Hydraulic Bow thrusters  
Dual Hydraulic Stern thrusters

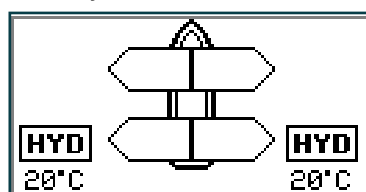

**PJC222:**

Dual AC Electric Bow thrusters  
Dual AC Electric Stern thrusters

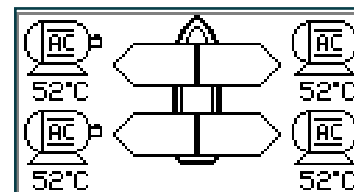

**DC Thrusters:**

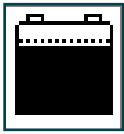

Battery indicator.  
From 8.5V to 12V for 12V thrusters,  
15V to 24V for 24V thrusters

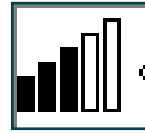

Motor temperature indicator.  
From 70°C/ 158°F to 130°C/266°F.

MC\_0947

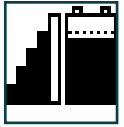

The battery indicator and motor temperature indicator are placed together in dual bow or dual stern installations. Indication levels are based on the same voltage and temperature range.

**AC Thrusters:**



← Motor temperature indicator.

**Hydraulic Thrusters:**



← Hydraulic oil temperature indicator.

**Retractable Thrusters:**



Symbol shown when the thruster deploys.



Symbol shown when the thruster retracts.



Symbol shown when the thruster is fully deployed.

When the thruster is fully deployed and not operated for 10 seconds, the internal buzzer will give an audible signal every 10<sup>th</sup> second to inform that the thruster is still deployed. It is also possible to configure the external buzzer to give the same audible signal, see the “Panel Setup - Menu” chapter for detailed information.

**Extended runtime Level symbol**

The 'L' is indicating that at least one of the BOW thrusters have it's output limited.

**Thrust power and direction, Bow thruster(s)**

Input from bow joystick on this panel.  
The thrust indicator will be shown in this position on a single joystick panel if the thruster is defined as a bow thruster

**Thrust power and direction, Stern thruster(s)**

Input from stern joystick on this panel  
The thrust indicator will be shown in this position on a single joy-

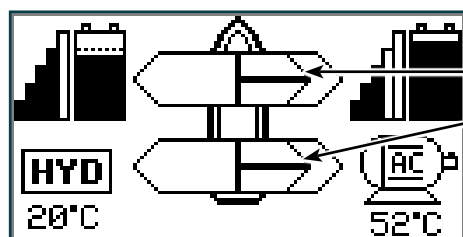
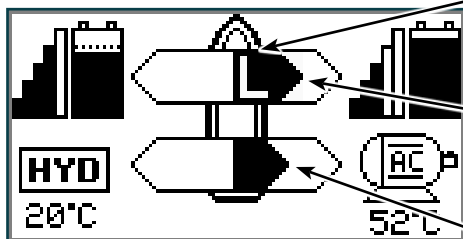

Indicating amount of thrust set by other control units in the system, i.e additional PJC panels, 8700 Retract panel, input via 8730 S-Link external switch interface, S-Link remote control etc.

If two or more units are set to run the thruster in

When an alarm is triggered, the panel will indicate this by changing the backlight colour of the LCD to red and activate the buzzer. In addition to the internal buzzer the panel has a relay output which could be used to activate an external buzzer. Optionally this output could also be used to lit a warning lamp or send signal to the vessels alarm and monitoring system. See “Control Panel Installation” chapter for detailed information on how to connect an external buzzer. The RELAY OUTPUT parameter configures when the relay output is activated, see “Panel Setup - Menu” chapter for detailed description.

Pressing the button below the “Alarm Info” symbol on the bottom of the screen will show fault code information. See example below.  
 Entering the “Alarm Info” menu will silence the alarm on all PJC2xx panels.

**Example PJC 212:**

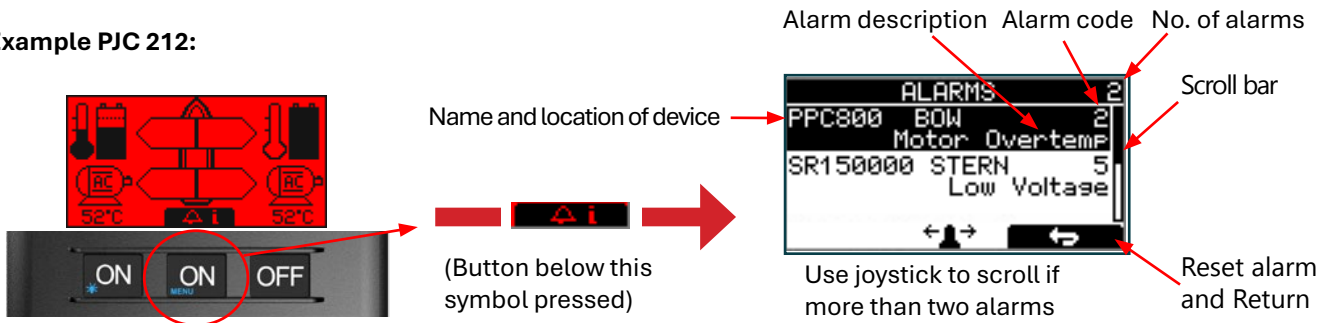

Refer to “Fault Code Navigator” chapter for full description of the different alarms.

**RESETTING OF ALARMS**

Some alarms need to be reset to stop alerting and some legacy alarms are automatically reset when the fault is no longer present. The alarms that are automatically reset do not need a manual reset action to be removed from the panel display and to stop the audible alert. The “Auto Reset” column in the “Alarm Description” chapter, in document “The Sleipner fault code lookup navigator” indicates which alarms that are auto reset. Refer to “Fault Code Navigator” chapter for full description of “The Sleipner fault code lookup navigator” document.  
 Alarms are reset by exiting the “Alarm Info” menu. If the alarm state is not resolved when the alarm is reset, the alarm will retrigger.

**ALARM SHOWN ON INACTIVE PANELS!**

This screen will be shown when any warning/alarm occurs.

Pressing the button below will mute buzzer alarm at all panels and show the alarm info screen.



**WARNING! HIGH SPEED. STABILIZER NOT ACTIVE!**

(Only for yachts equipped with a Side-Power Stabilizer system) Warning will show when yacht is driven at high speed with stabilizer system inactive. Please refer to the Stabilizer ECU manual for speed settings.

Pressing the button below will mute buzzer alarm at all panels and show the alarm info screen.



**HOLD FUNCTION - WARNING SIGNALS**

Refer to “HOLD Function” chapter for a description of potential warning signals when HOLD Function is activated.

**WHEN RETRACT IS OUT - WARNING**

Refer to the “Panel Setup - Menu” chapter for details on configuring of warning signal when retractable thrusters are deployed.

**RELAY OUTPUT - ALERT LEVEL**

For information on setting up which warnings alarms that activates the external buzzer, see the “Panel Setup - Menu” chapter.

## HOLD function

The HOLD function runs all installed thrusters in the same direction and at fixed levels. This function ease alongside docking and can be used to push the vessel towards the dock while mooring.

To enable the HOLD function press the + symbol of the HOLD button in the desired direction. The amount of thrust can be adjusted in 6 steps by pressing the + and – symbol of the HOLD button.

Once the HOLD function is enabled it is possible to further increase the thrust by moving the joystick past the point of applied thrust. When the joystick returns, thrust is kept at the level selected by the HOLD function.

Running the thrusters in the opposite direct will deactivate the HOLD function and stop thruster operation. Deactivation can be done by either pressing the - symbol down to zero thrust, moving the joystick in the opposite direction or pressing the + or - symbol of the opposite HOLD button.

### Calibration of HOLD function

The HOLD function can be calibrated to balance the thrust from bow and stern thrusters, and to limit the maximum thrust. See chapter “Setup – HOLD Calibration” for detailed description on how to calibrate the HOLD function.

### Warning signals

When using the HOLD function, warning signals will be given by the control panel if supply voltage or temperature is getting close to the alarm limit. Warning levels are signalled by the internal buzzer, and by the external buzzer if it is installed. The external buzzre will signal as staed below regardless of the configuration of the “Relay Output” parameter in the panel setup menu. On Warning level 3 the backlight of the display will also turn red. See table below for a detailed description of warning levels and signalling.

MC\_0916

Warning level	Warning signals	Cause
1.	Single short beep every 2.4 sec.	Voltage below 9.3V/17.5V (12V/24V system) or temperature above 85°C/185°F.
2.	Two short beeps every 2.4 sec.	Voltage below 8.9V/16.3V (12V/24V system) or temperature above 100°C/212°F.
3.	Continuous short beeps and red backlight in display.	Voltage below 8.5V/15V (12V/24V system) or temperature above 110°C/230°F.

The HOLD function is cancelled and all thrusters will stop, if the supply voltage or temperature exceeds beyond “Warning level 3” such that a thruster enters an alarm state.

## Combining hydraulic stabilizer with AC or DC thrusters

If the vessel has Sleipner hydraulic stabilizer system installed and AC or DC thrusters, the thruster location should be set as BOW-STB or STERN-STB. This ensures that the hydraulic controller is shown at the left side in display and thruster(s) at the right side of the display.

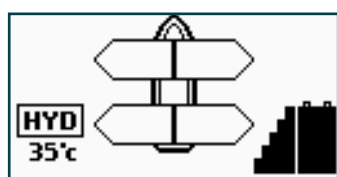

HYD-DC

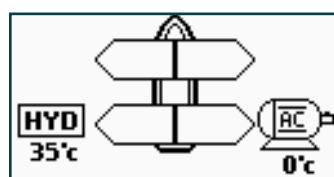

HYD-AC

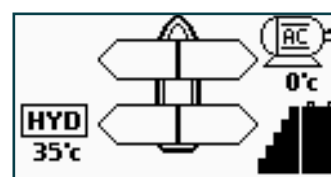

HYD-AC-DC

MC\_0919

## SAC power management status

Reduced Power Mode  
Thruster output is limited to 50 % thrust by Power Management System.

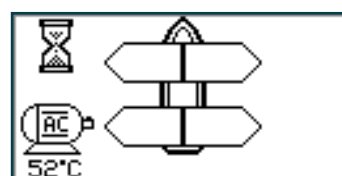
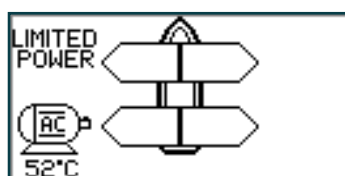

Power Not Available  
Power Management System is preventing the thruster from operating.

Symbol alternating with AC motor symbol every 1sec.

MC\_0758

(Note: For detailed information on SAC power management operation see SAC user manual.)

The main menu has 5 menu items, “SETUP” is by displayed as default when entering the menu system. If a Sleipner stabilizer system is installed, an additional menu item, “STABILIZER” will be available, and displayed as default when entering the menu system.

**MAIN MENU ITEMS:**  
Available menu items are listed below in the order that they appear in the control panel.  
The (stern) joystick is used to move between menu items.

Language	Stabilizer (If installed)	Setup	Info	Default settings	Panel setup

**BUTTON SYMBOLS**  
On the bottom line of the display, a symbol will be shown over the buttons below.  
These symbols will show what function each corresponding button has in the selected menu entry.

Return to previous menu	<b>Select</b> highlighted menu text or <b>Save</b> edited parameter.	<b>Edit</b> highlighted parameter.	<b>Cancel</b> editing without saving	This symbol indicates that the (stern) joystick is used to move between menu items or parameters.



Move around in menus by using joystick.  
Follow instructions on the screen and press the buttons below the symbols indicated on LCD screen.

Access menu system by pressing and holding Menu button for 3 seconds.

MG\_0965

**LANGUAGE**

A star (\*) on each side of the language indicates the currently selected language.

- Choose language by moving joystick: English, Norwegian, German, French, Spanish, Italian and Danish.
- Press the button below  to select the highlighted language.



MC\_0948

**Stabilizer menu**

**Note:** The stabilizer menu is only available on vessels equipped with a Sleipner stabilizer system.

**Stabilizer:**

Values: ON/OFF

Switches the stabilizer ON or OFF.

**AnySpeed:**

Values: ON/OFF

Switches the zero speed/at anchor stabilization ON or OFF.



MC\_0949

**Setup menu**

**SETUP**

The “SETUP” menu enables configuration of connected S-Link devices and the behaviour of the control panel’s joysticks.



MC\_0921

**Setup - system devices**

**SYSTEM DEVICES**

This menu lists all devices connected to S-Link and enable configuration of setup values.

A PIN code is required to enter the “SYSTEM DEVICES” menu. Use the (stern) joystick to set the pin code one number at a time. Press button below the  symbol to confirm and jump to the next number. The pin code is “9 9 9 9”.

The number of devices found is shown in the upper right corner of the display. Use (stern) joystick to move between the installed devices.

The list of devices found can fill more than one screen. A scroll bar indicates the position of the selected item.

Each of the listed devices can be selected for parameter configuration. Device configuration is described in the following sections.

Press button below the  symbol to save setting and return to the “SETUP” menu.

Exiting the “SYSTEM DEVICES” menu stores the system setup and distributes the system setup to all PJC2xx panels connected to the S-Link bus. The system setup consist of type of devices and location of all Sleipner products connected to the S-Link bus.

*(NB: Re-entering the “SYSTEM DEVICES” menu within 15 minutes does not require re-entering PIN code.)*

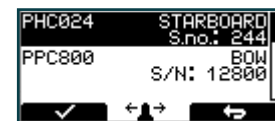

MC\_0922

### PDC 101 - Controller for AC thruster

PDC 101 must be setup by authorized personnel and is delivered preconfigure from factory. Firmware (FW) version and serial number (S/N) is Not Available (NA).

#### Location

Values: BOW/STERN/BOW-STB/STERN-STB

BOW or STERN in a conventional thruster system.

In a system with two bow or stern thrusters (e.g. a catamaran), BOW and STERN is port thruster, BOW-STB and STERN-STB is starboard thruster.

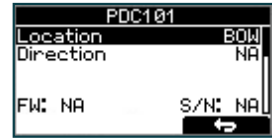

MC\_0926

(NB: If the boat has Sleipner hydraulic stabilizer and AC or DC thrusters the thruster location should be set as BOW-STB or STERN-STB. This so the hydraulic controller is shown at the left side in display and thruster(s) at the right side of the display.)

#### Direction

Values: NA (Not Available)

## Setup - PDC 201 AC system

### PDC 201 - Controller for AC thrusters

#### Location

Values: BOW/STERN/BOW-STB/STERN-STB

Set the location for selected device. Use BOW or STERN in a conventional thruster system.

In a system with two bow or stern thrusters (e.g. a catamaran), use BOW or STERN for port thruster, BOW-STB or STERN-STB for starboard thruster.

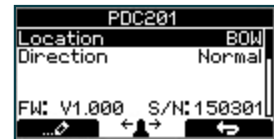

(NB: If the boat has Sleipner stabilizer and AC or DC thrusters the thruster location should be set as BOW-STB or STERN-STB. This so the hydraulic controller is shown at the left side in display and thruster(s) at the right side of the display.)



MC\_0927

#### Direction

Values: Normal (default)/Inverted

Switches between Normal and Inverted running direction for the thruster.

**PDC-301 - Controller for AC thrusters**

Firmware version and S-Link serial number are displayed at the bottom of the configuration menu.

**Location**

Values: BOW/STERN/BOW-STB/STERN-STB

Set the location for selected device. Use BOW or STERN in a conventional thruster system. In a system with two bow or stern thrusters e.g. a catamaran, use BOW or STERN for port thruster, BOW-STB or STERN-STB for starboard thruster.

(Note: If the boat has Sleipner hydraulic stabilizer and AC thrusters the thruster location should be set as BOW-STB or STERN-STB. Then the hydraulic controller is shown at the left side in the display and thruster(s) at the right side of the display.)

**Direction**

Values: Normal (default)/Inverted

Switches between Normal and Inverted running direction for the thruster. If the direction of thrust is opposite of the direction of movement of the joystick this parameter can be used to align thrust direction with the operation of the joystick.

**Function**

Values: SAC (default), SRAC

Setup the control unit behaviour.

-SAC: Tunnel thruster

-SRAC: SAC retractable thruster. SR150000 retractable controller must be set as SRHP/SRAC.

**Max output**

Values: 50% to 100% (Default 100%)

Set the maximum output thrust of PDC-301 in percent. PDC-301 will scale the input signal to this value.

**Load share limit**

Values: 0% to 100% (Default 100%)

The Load Sharing limitation allows the system to limit the combined load on the generator from a bow and stern thruster when both thrusters are used at the same time. The load sharing will dynamically limit the thrust request for each thruster depending on the joystick position and limit settings.

See AC series thruster user manual (document ID 6054) for a detailed explanation and setup guide.

**Drive Type**

Values: ACS580 (default), VACON, MB Profile 1, MB Profile 2

Select the type of Variable Frequency Drive (VFD) to be controlled by PDC-301. Select ACS580 if the drive is an ABB ACS580 or ACS880. MB Profile 1 and MB Profile 2 is two profiles only used with Danfoss ECS Systems.

**Asymmetric Thrust**

Values: 0% to 100% (Default 100%)

This setting can be used to improve performance of dual bow or stern thruster installations such as those found on catamarans or vessels with stern drive units. Pushing water at high flow into an adjacent tunnel may result in cavitation and reduction of thrust for the nearby tunnel.

Pushing water towards the drive unit, above a certain flow rate, might not further increase the thrust. Thus for vessels with stern drive and dual thruster installation the current consumption could potentially be improved by reducing flow towards the drive unit while not reducing maximum achieved thrust.

The Asymmetric Thrust value limits maximum thrust in one direction. The limiting direction is determined by the Location setting of the thruster.

Thrusters with Location set to BOW or STERN will limit thrust towards port side and hence reduce the water flow towards starboard.

Thrusters with Location set to BOW-STB/STERN-STB will limit thrust towards starboard side and hence reduce the water flow towards port.



MC\_0928

### AMS - Automatic Main Switch

#### Location

Values: BOW/STERN/BOW-STB/STERN-STB

Set the location for selected device. Use BOW or STERN in a conventional thruster system. In a system with two bow or stern thrusters (i.e a catamaran), use BOW or STERN for port thruster, BOW-STB or STERN-STB for starboard thruster.

(NB: If the boat has Sleipner hydraulic stabilizer and DC thrusters the thruster location should be set as BOW-STB or STERN-STB. This so the hydraulic controller is shown at the left side in display and thruster(s) at the right side of the display.)

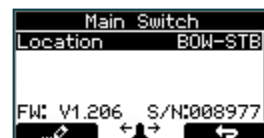

MC\_0929

**PPC - DC Speed Controller PPC520 / PPC800 / PPC820/ PPC840**

The Proportional Power Controller models PPC520, PPC800, PPC820 and PPC840 have the same configurable parameters. Firmware version and S-Link serial number are displayed at the bottom of the configuration menu.

**Location**

Values: BOW (default), STERN, BOW-STB, STERN-STB

Set the location for selected device. Use BOW or STERN in a conventional thruster system. In a system with two bow or stern thrusters, e.g. a catamaran, use BOW or STERN for port thruster, BOW-STB or STERN-STB for starboard thruster.



If the vessel has Sleipner hydraulic stabilizer installed and DC thrusters the thruster location should be set as BOW-STB or STERN-STB. This ensures that the hydraulic controller is shown at the left side in the display and thruster(s) at the right side of the display.

**Direction**

Values: Normal (default)/Inverted

Switches between Normal and Inverted running direction for the thruster. If the direction of thrust is opposite of the direction of movement of the joystick this parameter can be used to align thrust direction with the operation of the joystick.



For SRVP/SRLP retract installations Direction must be configured in the SR150000 for the direction change to take effect.

**Function**

Values: SEP (default), SRP, SRVP/SRLP

Configure thruster type.

- SEP: Tunnel speed thruster, PPC without retract.
- SRP: Retract SR6 1242 with PPC, both devices need to be set to SRP.
- SRVP/SRLP: Retract SR150000 with PPC, both devices need to be set to SRVP/SRLP.



**Max output**

Values: 50%-100% (default 100%)

Limits maximum thrust according to the configured value.

The thruster will linearly scale the joystick signal to the configured Max Output.



Applies for PPC800 from V1.022

Applies for PPC520/PPC820/PPC840 from V1.008

**Thermo Switch**

Values: Disable (default), Enable

Disable or Enables the thermo switch input on the PPC.

The thermo switch is normally closed and opens at high temperature.



On PPC520/PPC820/PPC840, if the thermo switch input is connected to GND at power-up then this parameter is automatically set to Enable.

Applies only for PPC520/PPC820/PPC840 from V1.016

**Extended runtime**

Values: ON (default), OFF

The extended runtime function will increase the thruster's maximum runtime, by reducing the maximum thrust when the motor temperature is high. Extended runtime can be used when thruster runtime needs to be extended, e.g. dynamic positioning- or docking systems.

OFF: Extended runtime function is disabled.

ON: Extended runtime function is enabled.



Applies for PPC520/820/840 from V1.030.

**Asymmetric thrust**

Values: 0% to 100% (Default 100%)

This setting can be used to improve performance of dual bow or stern thruster installations such as those found on catamarans or vessels with stern drive units. Pushing water at high flow into an adjacent tunnel may result in cavitation and reduction of thrust for the nearby tunnel.



Pushing water towards the drive unit, above a certain flow rate, might not further increase the thrust. Thus for vessels with stern drive and dual thruster installation the current consumption could potentially be improved by reducing flow towards the drive unit while not reducing maximum achieved thrust.

The Asymmetric Thrust value limits maximum thrust in one direction. The limiting direction is determined by the Location setting of the thruster.

Thrusters with Location set to BOW or STERN will limit thrust towards port side and hence reduce the water flow towards starboard.

Thrusters with Location set to BOW-STB/STERN-STB instance will limit thrust towards starboard side and hence reduce the water flow towards port.

**Exxx-xxV - eVision DC proportional thruster**

MC\_0931

eVision thrusters has several parameters that can be configured.

Exxx=thrust in kg  
 -xxV=operating voltage.

**Location**

Values: BOW (default), STERN, BOW-STB, STERN-STB

Set the location for selected device. Use BOW or STERN in a conventional thruster system. In a system with two bow or stern thrusters, e.g. a catamaran, use BOW or STERN for port thruster, BOW-STB or STERN-STB for starboard thruster.



If the vessel has Sleipner hydraulic stabilizer installed and DC thrusters the thruster location should be set as BOW-STB or STERN-STB. This ensures that the hydraulic controller is shown at the left side in the display and thruster(s) at the right side of the display.

**Direction**

Values: Normal (default)/Inverted

Switches between Normal and Inverted running direction for the thruster. If the direction of thrust is opposite of the direction of movement of the joystick this parameter can be used to align thrust direction with the operation of the joystick.



**Function**

Values: E (default), ERV/ERL

Configure thruster type.

- E - Tunnel thruster (default)
- ERV/ERL - Retractable eVision thruster



**Max output**

Values: 50%-100% (default 100%)

Limits maximum thrust according to the configured value.

The thruster will linearly scale the joystick signal to the configured Max Output.



**Asymmetric thrust**

Values: 0% to 100% (Default 100%)

This setting can be used to improve performance of dual bow or stern thruster installations such as those found on catamarans or vessels with stern drive units. Pushing water at high flow into an adjacent tunnel may result in cavitation and reduction of thrust for the nearby tunnel.



Pushing water towards the drive unit, above a certain flow rate, might not further increase the thrust. Thus for vessels with stern drive and dual thruster installation the current consumption could potentially be improved by reducing flow towards the drive unit while not reducing maximum achieved thrust.

The Asymmetric Thrust value limits maximum thrust in one direction. The limiting direction is determined by the Location setting of the thruster.

Thrusters with Location set to BOW or STERN will limit thrust towards port side and hence reduce the water flow towards starboard.

Thrusters with Location set to BOW-STB/STERN-STB instance will limit thrust towards starboard side and hence reduce the water flow towards port.



**Firmware**

List the current firmware of the eVision thruster.

**S-Link S/N**

List the S-Link serial number of the eVision thruster

**Product S/N**

List the product serial number of the eVision thruster



**SR150000 - Control unit for retract thrusters**

The Sleipner Retract Controller SR150000 is used to control and monitor deployment of retractable thrusters. Several parameters can be configured for SR150000. Firmware version and S-Link serial number are displayed at the bottom of the configuration menu.

**Location**

Values: BOW (default), STERN, BOW-STB, STERN-STB

Specify the physical location of the retractable thruster which SR150000 is connected to. Use Bow or Stern in conventional thruster system. In a system with two bow or two stern thrusters, for instance a catamaran, use Bow or Stern for port thruster. For starboard thrusters use Bow Starboard or Stern Starboard.



**Direction**

Values: Normal (default)/Inverted

Switches between Normal and Inverted running direction for the thruster. If the direction of thrust is opposite of the direction of movement of the joystick this parameter can be used to align thrust direction with the operation of the joystick.



For SRVP/SRLP retract installations Direction parameter set in PPC will not affect the running direction. In such installations it is only the Direction configuration in SR150000 that will control the running direction.

**Function**

Values: SR(V/L) ON/OFF (default), SRVP/SRLP, SRHP/SRAC, ERV/ERL

Configure thruster type controlled by the retract controller.

- SR(V/L) ON/OFF: DC thruster without speed controller. The joystick needs to be operated more than 50% for the thruster to run.
- SRVP/SRLP: DC thruster with PPC.
- SRHP/SRAC: Hydraulic or AC thruster.
- ERV/ERL: eVision thruster.



**Auto Retract Limit**

Values: OFF, 3kn, 4kn, 5kn (default), 6kn

The “Auto Retract Limit” is a safety feature that automatically retracts the thruster if the vessel speed exceeds the configured speed limit. It will also prevent deployment of the thruster if the vessel speed is above the configured speed limit. This functionality requires that a GPS is interfaced to the S-Link bus via GW-1.



If deployment has been suspended due to high speed, the thruster will automatically be deployed when the vessel speed decreases to 1 knot below the configured speed limit.

MC\_0932

The “Auto Retract Limit” function is designed as a safety precaution and should not be used as the primary method for retracting the thruster. The retract process takes several seconds, and high-speed vessels may reach high speeds before the hatch is fully closed. Therefore, it is strongly recommended to ensure that the thruster is fully retracted before increasing the vessel’s speed beyond five knots.

**SR6 1242 - Control unit for retract thrusters**

The Sleipner Retract Controller SR6 1242 is used to control and monitor deployment of retractable thrusters. Several parameters can be configured for SR6 1242. Firmware version and S-Link serial number are displayed at the bottom of the configuration menu.

**Location**

Values: BOW (default), STERN, BOW-STB, STERN-STB

Specify the physical location of the retractable thruster which SR6 1242 is connected to. Use Bow or Stern in conventional thruster system. In a system with two bow or two stern thrusters, for instance a catamaran, use Bow or Stern for port thruster. For starboard thrusters use Bow Starboard or Stern Starboard.

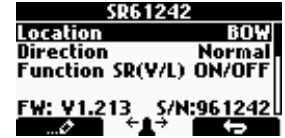

**Direction**

Values: Normal (default)/Inverted

Switches between Normal and Inverted running direction for the thruster. If the direction of thrust is opposite of the direction of movement of the joystick this parameter can be used to align thrust direction with the operation of the joystick.

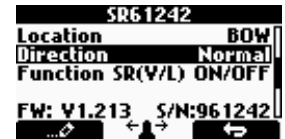

**Function**

Values: SR ON/OFF (default), SRP

Configure thruster type controlled by the retract controller.

- SR ON/OFF: DC thruster without speed controller. The joystick needs to be operated more than 50% for the thruster to run.
- SRP: DC thruster with PPC

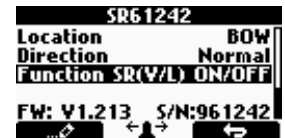

MC\_0933

Setup - SRC-3 Retract system

**SRC-3 - Control unit for retract thrusters**

The Sleipner Retract Controller SRC-3 is used to control and monitor deployment of retractable thrusters. Location parameter can be configured for SRC-3. Firmware version and S-Link serial number are displayed at the bottom of the configuration menu.

**Location**

Values: BOW/STERN/BOW-STB/STERN-STB

Set the location for the selected device. Use BOW or STERN in a conventional thruster system. In a system with two bow or stern thrusters (i.e. a catamaran), use BOW or STERN for port thruster, BOW-STB or STERN-STB for starboard thruster.

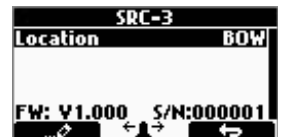

MC\_0934

Setup - RCRS 1 & RCRS 2 Remote control receiver

**RCRS 1 & RCRS 2 - Remote Control Receiver**

**BOW/STERN Thrust**

Values: 0-100% (Default 75%)

Set the amount of thrust given by the remote control.

In a bow/stern configuration, try to balance the thrust so that the boat moves straight sideways when both thrusters are operated simultaneously with input from the remote only.



MC\_0935

## MSI8730 - S-Link Interface

### Location

Values: BOW/STERN/BOW-STB/STERN-STB

Set the physical location for selected device. Use BOW or STERN in a conventional thruster system. In a system with two bow or stern thrusters (e.g. a catamaran), use BOW or STERN for port thruster and BOW-STB or STERN-STB for starboard thruster.



### Thrust

Values: 0-100% (Default 70%), in steps of 1%.

Set the amount of thrust requested when the 8730 input is activated. For vessels with a bow and stern thruster installation, it is recommended to balance the thrust so that the boat moves straight sideways when both thrusters are operated simultaneously.

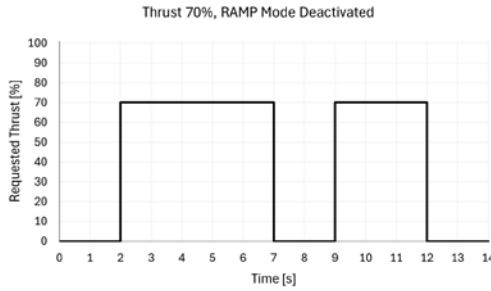

MC\_0936

### Final Thrust

Values: 0-100% (Default 100%), in steps of 1%.

RAMP mode is enabled by selecting a value for Final Thrust and specifying a RAMP Up time. The Final Thrust value must be larger than the configured Thrust value to enable RAMP mode. It is recommended to reduce the Thrust value below the default value of 70% to ensure a better user experience when RAMP mode is enabled.

RAMP mode enables variable thrust control when using ON/OFF control devices.



Note that due to the acceleration time of thruster motors there will be a small ramp time even if the RAMP mode is disabled. The graphs in this chapter describes the timing of the requested thrust from 8730 not the actual thrust of the thruster.

### RAMP Up

Values: Deactivated (Default) or 0.1-20 seconds in 0.1 seconds steps.

The RAMP Up time defines the time from activating the input of 8730 until the Final Thrust level is requested. During this time the requested thrust is linearly increased from the specified Thrust value to the value of Final Thrust. See graphs below for details.



### RAMP Down

Values: 0-20 seconds in 0.1 seconds steps (Default 0 seconds).

The RAMP Down parameter can be used to control the thrust level when reactivating the input of 8730. This is typically applicable when pulsing the input of 8730 ON and OFF. The reactivation level will be linearly decreased from the thrust value used when 8730 input is disabled and down to the configured Thrust value. Thus if the time span before reactivating the thruster is longer than the RAMP Down time, the reactivation level will be set to the configured Thrust value.



The reactivation level will be similar even if the direction of thrust is changed.

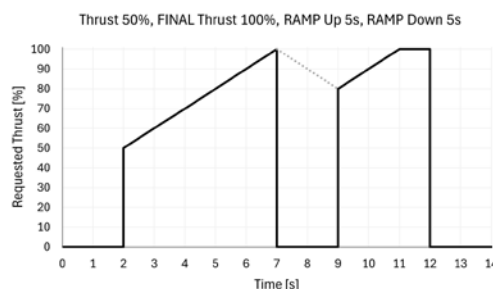
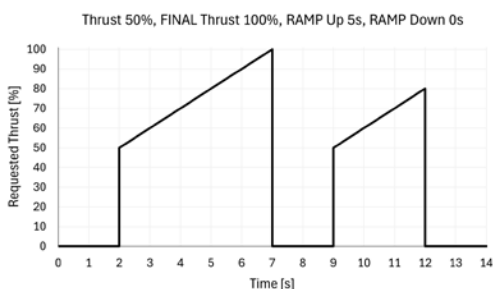

## ESI-1 - External Signal Interface GW-1 - S-Link Gateway

These devices will only show firmware version and serial number at the bottom.

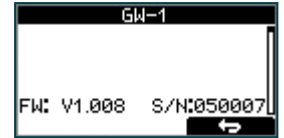

MC\_0937

## Setup - HOLD Calibration

### HOLD CALIBRATION

Changes done to settings in the “HOLD CALIBRATION” menu will be sent to all other PJC2xx panels connected to the S-Link bus.

The HOLD function can be calibrated to get balanced thrust from the bow and stern thruster. Due to different size of bow and stern thrusters or the vessel’s shape, it may be required to have different thrust level on bow and stern thrusters to ensure that the vessel moves sideways while maintaining its heading, when the HOLD function is activated.



The calibration also set the maximum available thrust when using the HOLD function. The default maximum thrust is 70% and since long run time is often desirable when using the HOLD function it is recommended to configure for a maximum thrust level lower than 100%.

If only a bow or a stern thruster is installed the calibration will only adjust the maximum thrust level for the HOLD function.

*(NB: HOLD CALIBRATION is not available until SETUP is completed.)*

To start calibration, press the + symbol on the HOLD button in the desired direction. For first time calibration, the thrusters will start at 70% thrust.

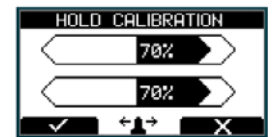

A system previously calibrated will start with the last configured maximum thrust.

Use the joystick to adjust the thrust until the vessels moves sideways while maintaining its heading, and maximum thrust is at a desired level. Thrust can be adjusted in steps of 1%.

MC\_0938

Press the button below  to save the calibration values.

Press the button below  to cancel calibration without saving.

*(NB: HOLD Calibration is done for one direction and the same calibration values are used for operation in the oppsite directions.)*

**JOYSTICK CALIBRATION**

The Joystick Calibration menu is only available on PJC2xx panels with HW V2 or higher.



This option is for service personnel only. A PIN code is required to enter the “Joystick Calibration” menu. Use the (stern) joystick to set the pin code one number at a time, press button below the  symbol to confirm and jump to next number. The pin code is “1 9 0 8”.

Follow the instruction on the display to perform calibration of joysticks.



MC\_0939

**Info - Menu**

- Move between menu items with the (stern) joystick.
- Press the button below  to select the highlighted menu entry.
- Press the button below  to return to the previous menu.



MC\_0940

**Info - Thruster info**

**THRUSTER INFO**

**THRUSTER INFO**

Display info about the thrusters in the system. The number of thrusters/controllers found is shown in the upper right corner of the display.

The list of devices found can fill more than one screen. A scroll bar indicates the position of the selected item. The joystick(s) operates the thrusters as normal while info is displayed. This will be useful for troubleshooting, service and general system diagnostics. List will only show devices present on the S-Link.

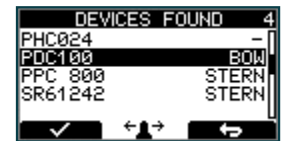

MC\_0952

**Info - PPC, SR150000, SR6 1242**

**PPC DC Speed Controller**

**SR150000** Retract controller

**SR6 1242** Retract controller

Motor Temp: Temperature measured at the electric motor brushes  
(Not implemented in SR6 1242)

Contr. Temp: Temperature measured inside the controller  
(Not implemented in SR6 1242)

Voltage: Motor Voltage measured at the controller

Thrust: Thrust level from joystick/hold buttons

%A/kW: Retract angle (SR150000) / Motor Current (PPC) / Power reading (PPC). SR150000 retract angel is 0° when fully deployed, and about 90° when retracted. Put SR150000 in service mode and operate the controller manually in an out to read the two end position angels for service and installation.

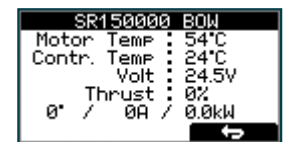

MC\_0941



## Info - Panel info

Display info about the control panel

- FW: Version number, Firmware
- HW: Version number, Hardware
- S/N: Serial number of the control panel
- Voltage: S-Link system voltage measured at the panel

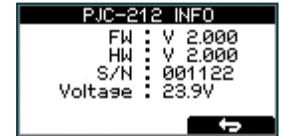

MC\_0945

## Info - S-link diagnostic

- Shows live update of S-Link bus (CAN-bus) error status for the panel.
- Showing no error and signal condition is good.
- Example showing lots of errors and very bad signal conditions.

### DIAGNOSTIC DISPLAY

#### Rx Error Count

Receive error counter. Error during reception increments the value. After every successful reception the value is decremented.

#### Tx Error Count

Transmit error counter. Error during transmit increments the value. After every successful transmission the value is decremented.

#### Last Error

Indicates the error condition of the last error detected. If a message has been transferred or received without error, it will show No Error.

Conditions: No Error, STUFF, FORM, ACK(Acknowledgment), BitRecessive, BitDominant & CRC.

#### Flag

BUS OFF: when Tx Error Count is greater than 255 and overflowed. (Tx Error Count will show 0 when in BUS OFF state)

WARNING: when Rx Error Count or Tx Error Count has reached 96 counts

PASSIVE: when Rx Error Count or Tx Error Count is more than 127 counts

(NB: When S-Link devices are hot plugged or disconnected from the bus, or powered (when AMS is engaged and powering PPC and retract), it is not unusual to see some values been incremented. But they will quickly decrement to 0 again. This will not cause any communication issues.)

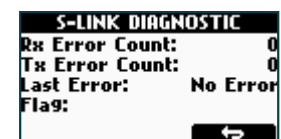

MC\_0946

## Default settings - Menu

### DEFAULT SETTINGS

This menu entry enables resetting all panel settings to factory default.

- Press the button below  to confirm reset
- The following parameters values will be set to the factory settings:

Language = English  
 Backlight Level = 5  
 Backlight Night Colour = Green  
 Backlight Night Level = 1  
 Timer Auto-Off = 05 min  
 Hold Calibration = 70% Bow and Stern

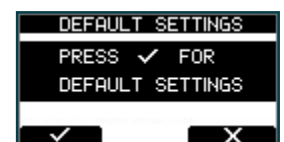

MC\_0950

All system devices will be erased from memory.  
 Setup procedure must be followed to reconfigure the system.

**Panel Setup**

This menu enables configuration of panel properties.

MC\_0101

**BACKLIGHT LEVEL**

Values: 1-5

Set level of panel back light in daylight mode. 1 is lowest intensity, 5 is the highest.



**BACKLIGHT NIGHT COLOUR**

Values: GREEN, BLUE, RED, WHITE

Select colour of backlight in night light mode.



**BACKLIGHT NIGHT LEVEL**

Values: 1-3

Set level of panel backlight in daylight mode, 1 is lowest intensity, 3 is the highest.



**TIMER AUTO-OFF**

Values: OFF, 01-60 min

Set the time from last use to auto panel shut-down. Set from 1-60 minutes in 5 minute steps (1 minute steps from 1 to 5 minutes) or OFF (panel will not turn off automatically). Values when retract on the boat: 1-30 min.



**UNIT TEMPERATURE**

Values: CELSIUS (Default), FAHRENHEIT

Set the panel temperature displaying unit.

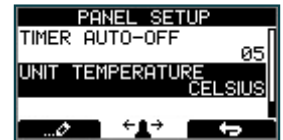

**WHEN RETRACT IS OUT**

Values: NO WARNING (Default), WARNING EVERY 10sec

WARNING EVERY 10sec enables the external buzzer to give an audible signal every 10<sup>th</sup> second if the thruster is fully deployed and not operated over a 10 second period. In such situations the internal buzzer will always give the same audible signal. See “Control Panel Installation” chapter for detailed information on how to connect an external buzzer.



**RELAY OUTPUT**

Values: ALERT LEVEL 1 , ALERT LEVEL 2 , ALERT LEVEL 3 (Default)

The RELAY OUTPUT parameter configures which alarms and warnings that activates the relay output. “Ext. buzzer activation at Alert Level” column in the “Alarm Description” chapter, in document “The Sleipner fault code lookup navigator” shows which alarms that will activate the relay output for the different “ALERT LEVEL” configurations. The relay output will be activated even if the panel is turned OFF.



For ALERT LEVEL 2” The relay output is only activated when a control device is sending thrust.

Refer to “Fault Code Navigator” chapter for full description of “The Sleipner fault code lookup navigator” document.

**PANEL FACING**

Values: FORWARD (Default), AFT

FORWARD: Is when panel is facing forward

AFT: Is when panel is facing aft. Display view will rotate 180° and joysticks thruster function will also rotate 180°.



**Stabilizer ALARMS**

Values: Disabled, Enabled (Default)

Disabled: Panel will not alert any stabilizer alarms. This is useful when a PJC2xx panel is mounted close to a TP-43A panel, and will prevent both panels to alert at the same time.

Enabled: PJC2xx panel will alert stabilizer alarms.



Fault situations in S-Link compliant products generates Fault Codes which are broadcasted on the S-Link bus. If a control panel receives a Fault Code, it will trigger an alarm in the control panel and the user will be able to get information about which product that reports the fault and the reason for the fault. Please see the user manual of your S-Link compliant control panel for more information on how to access Fault Code information in case of an alarm situation.

All Sleipner S-Link compliant products have product specific Fault Codes. For legacy reasons some control panels display Generic Fault Codes for certain products.

MC\_0472

## Fault Code Navigator

Scan the QR code to access Sleipner's Fault Code Navigator. Fault codes can be entered in the Fault Code Navigator to receive fault description and guidance on resolving the issue.

A complete list of fault codes and troubleshooting tips can also be downloaded.

[www.sleipnergrouper.com/support/fault-code-navigator](http://www.sleipnergrouper.com/support/fault-code-navigator)



MC\_0974

### General:

- The installer must read this document to ensure necessary familiarity with the product before installation.
- Directions outlined in this document cannot be guaranteed to comply with all international and national regulations, including but not limited to health and safety procedures. It is the installers responsibility to adhere to all applicable international and national regulations when installing Sleipner products.
- This document contains general installation guidelines intended to support experienced installers. Contact professional installers familiar with the vessel, Sleipner products and applicable regulations if assistance is required.
- If local regulation requires any electrical work to be performed by a licensed professional, seek a licensed professional.
- When planning the installation of Sleipner products, ensure easy access to the products for future service and inspection requirements.

MC\_0038

### Sleipner S-Link™ Systems

- Only Sleipner S-Link™ products or authorized third-party control equipment may be connected directly to the S-Link™ bus.
- Non-authorized third-party equipment must always be connected through a Sleipner interface product.
- Connecting unauthorized equipment directly to the S-Link™ bus will void all warranties for connected Sleipner products.
- If third-party control equipment is interfaced to the S-Link™ bus through a Sleipner interface product, at least one Sleipner control panel must be installed to enable efficient system diagnostics and troubleshooting.

MC\_0105

Dimension code	Dimension description	PJC2xx	
		mm	inch
H	Panel Height	141	5.55
W	Panel width	83	3.3
(a)	Raised height above the dashboard	65.66	2.6
(b)	Depth behind the dashboard (not inc. cables)	31.8	1.25
(c)	Panel screw hole diameter	4.5	0.18
(d)	Distance between panel screw holes	132.7	5.22
(e)	Distance between panel screw holes	75.7	3
(f)	Panel cut out height	125	4.9

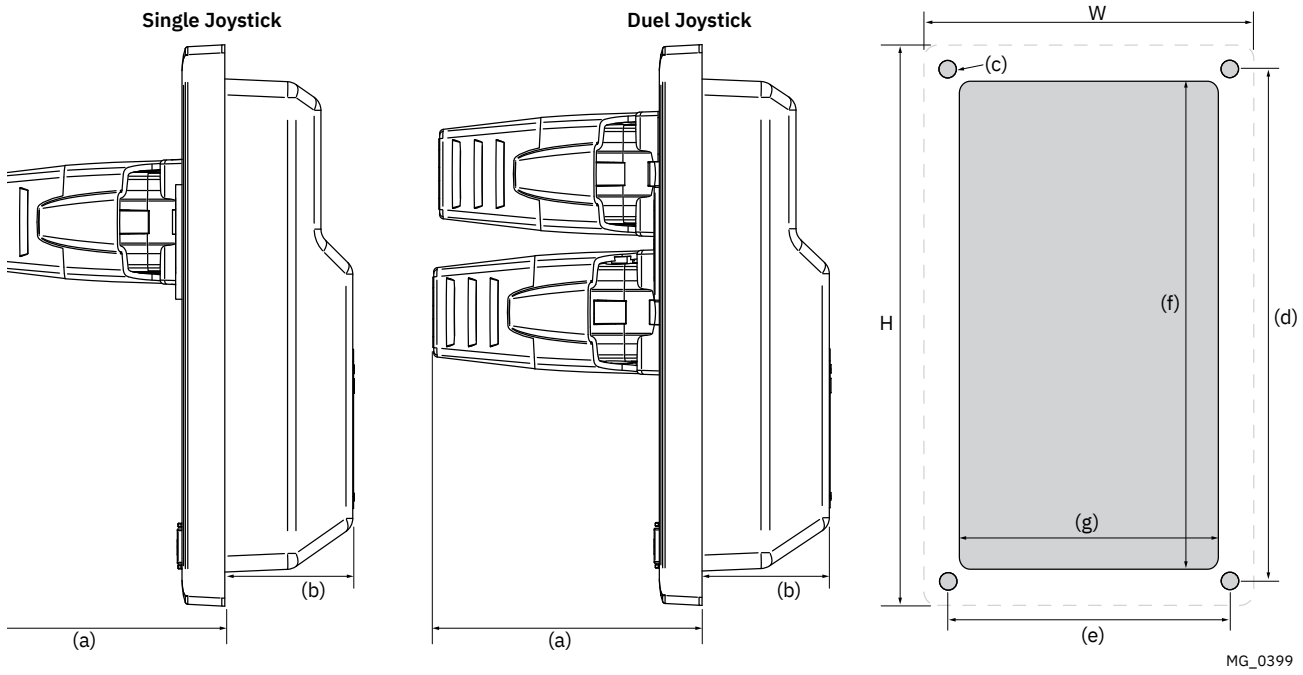

MG\_0399

Product specifications

Description	Minimum	Maximum	Units	Comment
Input voltage	9	31	Volt DC	Powered from S-Link
Input current	20	120	mA	
External Alarm Buzzer Voltage		31	Volt DC	
External Alarm Buzzer Current		500	mA	Internally fused

Description	Value
Operating temperature	-10 to + 60 degrees C.
Storage temperature	-20 to + 70 degrees C.
IP rating front	IPx6
IP rating back	IPx4
Humidity	max 95% RH
EMC tested	Acc. to EN 60533
Weight	215 gr.

Select a suitable location for the control panel where it will not obstruct, or be obstructed by, other equipment. Ensure the mounting surface is flat and allows easy operation of the panel. The control panel must be mounted at least 20 cm away from any compass to avoid affecting compass accuracy.

1. Use the supplied cut-out template to mark the required opening on the control dashboard.
2. Cut the opening according to the template dimensions.
3. Fit the gasket to the rear face of the control panel. (*Note: If the surface around the cut-out is uneven, jagged, or chipped, apply a suitable sealant to assist gasket sealing.*)
4. Connect the S-Link Spur cable to the S-Link connector on the rear of the control panel. Refer to the S-Link System Description chapter for detailed information regarding installation of the S-Link POWER cable, END terminator, and additional S-Link components. Connection of an external alarm buzzer is optional. The buzzer output is controlled by an internal relay and protected by an internal fuse.
5. Insert the control panel into the cut-out and fasten the mounting screws. (*Note: Apply grease to the nut threads and tighten slowly to prevent galling.*)

MC\_0902

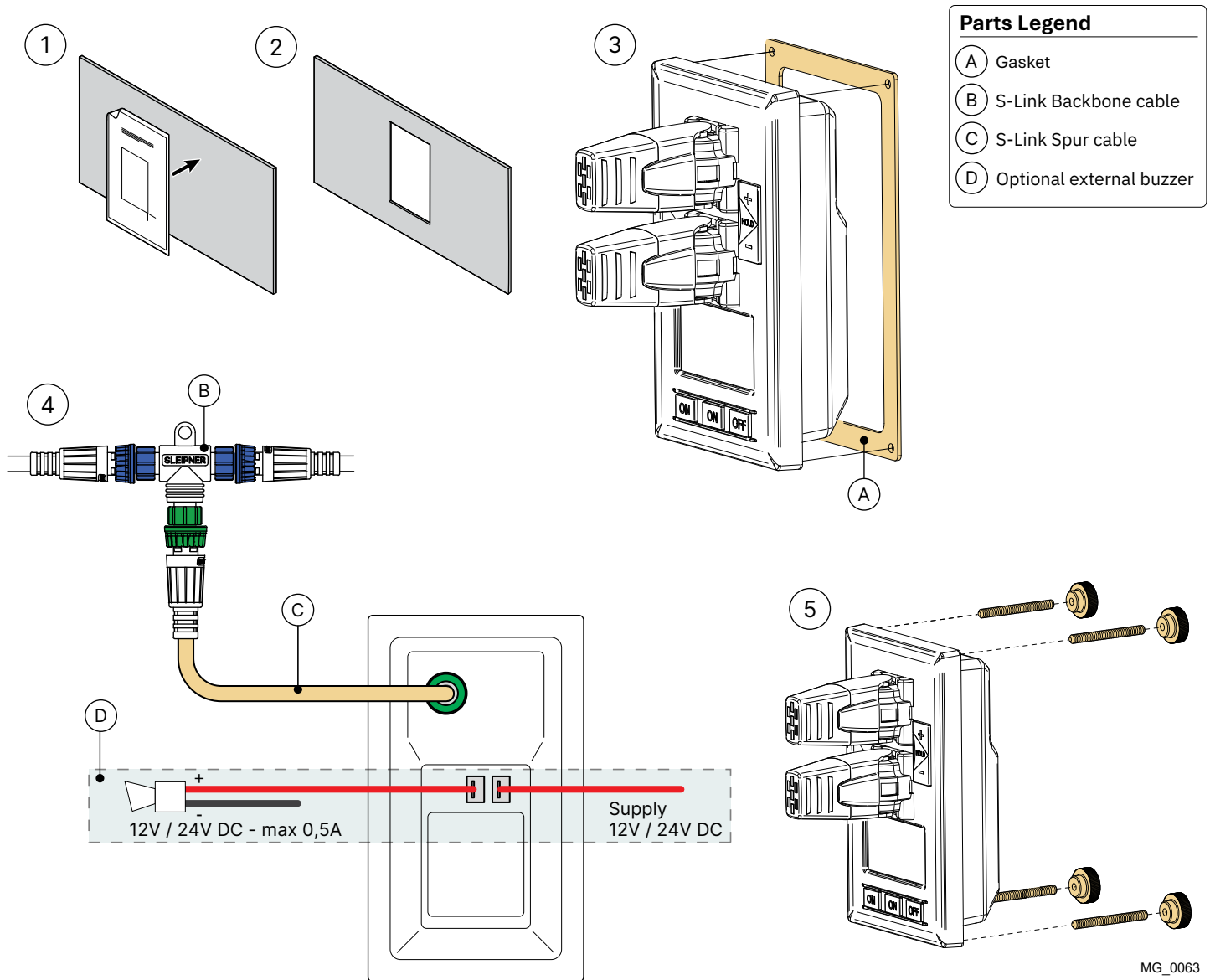

MG\_0063

S-Link is a CAN-based control system used for communication between Sleipner products installed on a vessel. The system uses BACKBONE Cables as a common power and communication bus with separate SPUR Cables to each connected unit. Only one S-Link POWER cable shall be connected to the BACKBONE Cable. Units with low power consumption are powered directly from the S-Link bus.

**Main advantages of S-Link system:**

- Compact and waterproof plugs.
- BACKBONE and SPUR Cables have different colour coding and keying to ensure correct and easy installation. BACKBONE Cables have blue connectors and SPUR Cables have green connectors.
- Different cable lengths and BACKBONE Extenders make the system scalable and flexible to install.

**Installation of S-Link cables:**

Select appropriate cables to keep the length of BACKBONE- and SPUR Cables to a minimum. In case of planned installation with total BACKBONE Cable length exceeding 100 meters please consult your local distributor. The S-Link cables should be properly fastened when installed to avoid sharp bend radius, cable chafing and undesired strain on connectors. Locking mechanism on connectors must be fully closed. To ensure long lifetime, cables, T-Connectors and Extenders should not be located so that they are permanently immersed in water or other fluids. It is recommended to install cables in such a way that water and condensation do not flow along the cables into the connectors. This can be done for example by introducing a u-shape bend before the cable enters the product connector.

Ideally, the POWER Cable should be connected to the middle of the BACKBONE bus to ensure an equal voltage drop at both ends of the BACKBONE Cable. The yellow and black wire in the POWER Cable shall be connected to GND and the red wire connected to +12VDC or +24VDC.

To reduce the risk of interference, avoid routing the S-Link cables close to equipment such as radio transmitters, antennas or high voltage cables. The backbone must be terminated at each end with the END Terminator.

SPUR cables can be left unterminated to prepare for the installation of future additional equipment. In such cases, ensure to protect open connectors from water and moisture to avoid corrosion in the connectors.

MC\_0120

<p><i>*Blue ends</i></p>	<p><b>BACKBONE Cable</b> Forms the communication and power bus throughout a vessel. Available in different standard lengths.</p>	<p><i>*Blue ends</i> <i>*Blue ends</i> <i>*Green ends</i></p>	<p><b>T-Connector</b> Used for connection of SPUR or POWER Cable to the BACKBONE Cable. One T-Connector for each connected cable.</p>	
<p><i>*Green ends</i></p>	<p><b>SPUR Cable</b> Used to connect S-Link compliant products to the backbone cable. One SPUR Cable must be used for each connected component, with no exceptions. Recommended to be as short as practically possible. Available in different standard lengths.</p>	<p><i>*Blue ends</i> <i>*Blue ends</i></p>	<p><b>BACKBONE Extender</b> Connects two BACKBONE Cables to extend the length.</p>	
<p><i>*Green ends</i></p>	<p><b>POWER Cable</b> Required in all installations for connection of BACKBONE Cable to a power supply and should be protected with a 2A fuse.</p>	<p><i>*Blue ends</i></p>	<p><b>END Terminator</b> Must be one at each end of the BACKBONE bus.</p>	
<p><i>*Blue ends</i> <i>*Blue ends</i> <i>*Green ends</i></p>				<p><b>4-Port T-Connector</b> The 4-PORT T-connector allows multiple SPUR Cables to be connected. The 4-PORT T-connector comes with two sealing caps to protect unused ports.</p>

**S-Link installation example**

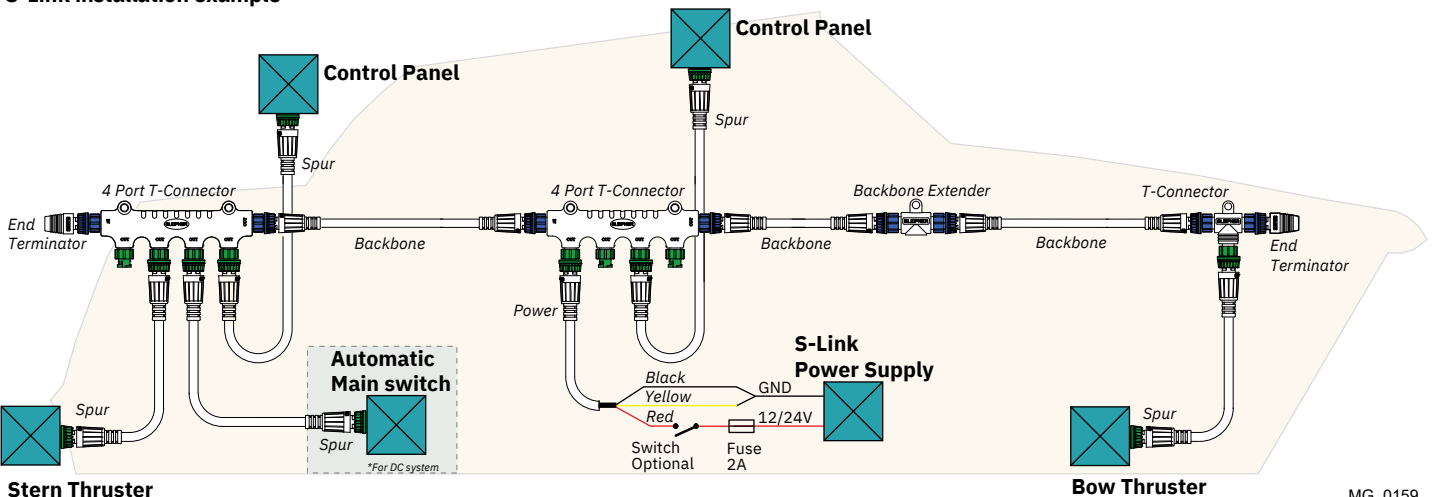

MG\_0159



## Introduction:

At Sleipner Group, we prioritize sustainability and encourage the repair and re-manufacturing of products to extend their life cycles. If disposal is necessary, please follow these guidelines to recycle and manage waste responsibly, ensuring our efforts align with environmental protection efforts.

## Electric Motors and Electronics

- Disconnect from any power sources and dismantle them carefully.
- Recycle components through certified e-waste recycling centers that can adequately handle and recover electronic materials.
- Dispose of any non-recyclable electronic parts according to local environmental regulations.

## Metals:

- Collect and sort metal parts for recycling as scrap metal.
- To increase recycling efficiency, ensure that metals are clean and free from non-metal attachments.

## Plastics:

- Identify recyclable plastics based on local recycling guidelines.
- Remove any non-plastic components and clean them before recycling to improve the quality of the recycled material.

## Hazardous Materials:

- Correctly identify any hazardous substances within components, such as batteries or capacitors etc.
- Follow local regulations for the safe disposal of hazardous materials to prevent pollution and protect environmental health.

## General Disposal Instructions:

- Consult local recycling programs to determine the acceptability of various materials.
- Use authorized disposal services to ensure compliance with environmental standards.

## Safe Disposal Practices:

- Adhere to local laws and regulations for waste management to minimize environmental impact and ensure community safety.

This guide is designed to help reduce our products' environmental footprint through responsible end-of-life management. Please contact your local waste management supplier or our support team for more specific disposal information or further assistance.

MC\_0848

Find your local certified dealer through our global network to receive expert service and support. Visit our website for more information: [www.sleipnergroupp.com/support](http://www.sleipnergroupp.com/support)



## Product Spare Parts and Additional Resources

---

For additional supporting documentation, visit our website at [www.sleipnergroupp.com](http://www.sleipnergroupp.com) and locate your specific Sleipner product.



## Patents

---

At Sleipner we continually reinvest to develop and offer the latest technology in marine advancements. To see the many unique designs we have patented, visit our website: [www.sleipnergroupp.com/patents](http://www.sleipnergroupp.com/patents)



MC\_0024

1. Sleipner Motor AS (The “Warrantor”) warrants that the equipment (parts, materials, and embedded software of products) manufactured by the Warrantor is free from defects in workmanship and materials for purpose for which the equipment is intended and under normal use and maintenance service (the “Warranty”).
2. This Warranty is in effect for two years (Leisure Use) or one year (Commercial and other Non-leisure Use) from the date of delivery/purchase by the end user, with the following exceptions:
  - (a) For demonstration vessels, or vessels kept on the water, the dealer is considered as the end user from 6 months after their launch of the vessel;
  - (b) The warranty period starts no later than 18 months after the first launch of the vessel.Please note that the boat manufacturer and dealer must pay particular attention to correct maintenance and service both by the products manuals as well as general good practice for the location the boat is kept in the period the boat is in their care. In cases where the 6 and 18 months grace periods for boat builders and dealers are passed, it is possible to obtain a full warranty upon inspection and approval of the warrantor or such representative.
3. Certain parts, classified as wearable or service parts, are not covered by the warranty. A failure to follow the required maintenance and service work as described in the product manual render all warranty on parts or components directly or indirectly affected by this void. Please also note that for some parts, time is also a factor separately from actual operational hours.
4. This Warranty is transferable and covers the equipment for the specified warranty period.
5. The warranty does not apply to defects or damages caused by faulty installation or hook-up, abuse or misuse of the equipment including exposure to excessive heat, salt or fresh water spray, or water immersion except for equipment specifically designed as waterproof.
6. In case the equipment seems to be defective, the warranty holder (the “Claimant”) must do the following to make a claim:
  - (a) Contact the dealer or service centre where the equipment was purchased and make the claim. Alternatively, the Claimant can make the claim to a dealer or service centre found at [www.sleipnergroun.com](http://www.sleipnergroun.com). The Claimant must present a detailed written statement of the nature and circumstances of the defect, to the best of the Claimant’s knowledge, including product identification and serial nbr., the date and place of purchase and the name and address of the installer. Proof of purchase date should be included with the claim, to verify that the warranty period has not expired;
  - (b) Make the equipment available for troubleshooting and repair, with direct and workable access, including dismantling of furnishings or similar, if any, either at the premises of the Warrantor or an authorised service representative approved by the Warrantor. Equipment can only be returned to the Warrantor or an authorised service representative for repair following a pre-approval by the Warrantor’s Help Desk and if so, with the Return Authorisation Number visible postage/shipping prepaid and at the expense of the Claimant.
7. Examination and handling of the warranty claim:
  - (a) If upon the Warrantor’s or authorised service Representative’s examination, the defect is determined to result from defective material or workmanship in the warranty period, the equipment will be repaired or replaced at the Warrantor’s option without charge, and returned to the Purchaser at the Warrantor’s expense. If, on the other hand, the claim is determined to result from circumstances such as described in section 4 above or a result of wear and tear exceeding that for which the equipment is intended (e.g. commercial use of equipment intended for leisure use), the costs for the troubleshooting and repair shall be borne by the Claimant;
  - (b) No refund of the purchase price will be granted to the Claimant, unless the Warrantor is unable to remedy the defect after having a reasonable number of opportunities to do so. In the event that attempts to remedy the defect have failed, the Claimant may claim a refund of the purchase price, provided that the Claimant submits a statement in writing from a professional boating equipment supplier that the installation instructions of the Installation and Operation Manual have been complied with and that the defect remains.
8. Warranty service shall be performed only by the Warrantor, or an authorised service representative, and any attempt to remedy the defect by anyone else shall render this warranty void.
9. No other warranty is given beyond those described above, implied or otherwise, including any implied warranty of merchantability, fitness for a particular purpose other than the purpose for which the equipment is intended, and any other obligations on the part of the Warrantor or its employees and representatives.
10. There shall be no responsibility or liability whatsoever on the part of the Warrantor or its employees and representatives based on this Warranty for injury to any person or persons, or damage to property, loss of income or profit, or any other incidental, consequential or resulting damage or cost claimed to have been incurred through the use or sale of the equipment, including any possible failure or malfunction of the equipment or damages arising from collision with other vessels or objects.
11. This warranty gives you specific legal rights, and you may also have other rights which vary from country to country.









# SLEIPNER

*Ocean born. Tech bred.*

**SLEIPNER MOTOR AS**

P.O. Box 519

N-1612 Fredrikstad

Norway

[www.sleipnergroun.com](http://www.sleipnergroun.com)

Made in Norway

© Sleipner Motor AS, All rights reserved

The information given in the document was right at the time it was published. However, Sleipner Motor AS cannot accept liability for any inaccuracies or omissions it may contain. Continuous product improvement may change the product specifications without notice. Therefore, Sleipner Motor AS cannot accept liability for any possible differences between product and document. Learn more about our products at [www.sleipnergroun.com](http://www.sleipnergroun.com)